

User Guide

INSIGNIA™

37" LCD TV

NS-LCD37HD-09

Insignia NS-LCD37HD-09

37" LCD TV

Contents

Introduction	1
Safety information	3
Features	5
Front	5
Right side buttons	5
Right side jacks	5
Left side	6
Remote control	6
Setting up your TV	7
Installing remote control batteries	7
Connecting an antenna, cable TV, or satellite TV box	7
Connecting an HDMI device	8
Connecting a component video device	8
Connecting a VCR for playback	9
Connecting a VCR for recording	9
Connecting a camcorder or game	9
Connecting a computer	10
Connecting a digital sound system	10
Connecting headphones	10
Connecting the power cord	11
Using your TV	11
Turning your TV on or off	11
Using the remote control	11
Selecting the video input source	11
Selecting the TV signal source	11
Scanning for channels	12
Deleting channels	13
Changing channels	13
Adjusting the volume	13
Adjusting the picture	14
Reducing video noise (snow)	14
Optimizing the picture	14
Adjusting the sound	15
Selecting the audio mode	15
Setting the clock	15
Setting the sleep timer	16
Selecting the aspect ratio	16
Turning closed captioning on or off	17
Selecting the closed captioning mode	17
Customizing DTV closed captioning styles	18
Setting up the favorite channel list	18
Labeling channels	19
Selecting the on-screen menu language	19
Displaying the information banner	20
Displaying the DTV program guide	20
Checking the DTV signal strength	20
Playing TV audio only	20
Labeling an input source	20
Resetting an input label	21
Setting the parental password	21
Turning the parental lock on or off	22
Setting parental controls	22
Downloading rating information	24
Adjusting the computer image	24
Adjusting advanced computer settings	25
Adjusting the menu transparency	25
Restoring default settings	25
Maintaining	26
Troubleshooting	26
Specifications	27
One year limited warranty	29

Introduction

Congratulations on your purchase of a high-quality Insignia product. Your NS-LCD37HD-09 represents the state of the art in LCD TV design and is designed for reliable and trouble-free performance.

CHILD SAFETY

It makes a difference how and where you use your flat panel display

As you enjoy your new product, keep these safety tips in mind

The issue

The home theater entertainment experience is a growing trend, and larger TVs are popular purchases. However, TVs are not always supported on the proper stands or installed according to the manufacturer's recommendations. We and the consumer electronics industry are committed to making home entertainment enjoyable and safe. *TVs that are inappropriately placed on dressers, bookcases, shelves, desks, speakers, chests, or carts may fall over and cause injury.*

Tune into safety

- One size of TV stand does **not** fit all. Use only a TV stand rated for the weight of your TV.
- Carefully read and understand all enclosed instructions for proper use of this product.
- Don't let children to climb on or play with entertainment system furniture and TVs.
- Don't place TVs on furniture that can easily be used as steps, such as a chest of drawers.
- Remember that children can become excited while watching a program, especially on a "larger-than-life" TV. Make sure that you place or install the TV where it cannot be pushed, pulled over, or knocked down.
- Make sure that you route all cords and cables so that they cannot be pulled or grabbed by curious children.



Wall mounting

If you decide to wall mount your TV, always:

- One size of wall mount does **not** fit all. Use only a wall mount rated for the weight of your TV and that has been recommended by this TV manufacturer, listed in this manual, or otherwise listed by an independent laboratory (such as UL, CSA, or ETL) as suitable for your TV.
- Follow all instructions supplied by the TV and wall mount manufacturers.
- If you have any doubts about your ability to safely wall mount your TV, get help from a professional installer.
- Make sure that the wall where you are mounting the TV is appropriate. Some wall mounts are not designed to be mounted to walls backed with steel studs or cinder blocks. If you are unsure, ask a professional installer.
- TVs can be heavy. At least two people are required for safe wall mount installation.



Safety information

Warning

To prevent electric shock, match the wide blade on the power cord plug to the wide slot on an electric outlet. If the plug does not fit, consult a licensed electrician to replace the obsolete outlet. Do not modify the power cord plug, or you will defeat this safety feature.



This symbol indicates that dangerous voltage constituting a risk of electric shock is present within your TV. This label is located on the back of your TV.



This symbol indicates that there are important operating and maintenance instructions in the literature accompanying your TV.

Warning

Your TV contains a fluorescent lamp containing a small amount of mercury. Disposal of these materials may be regulated for environmental reasons. For disposal or recycling information, contact your local authorities or the Electronic Industries Alliance at www.eia.org.

Read instructions

Read all of the safety and operating instructions before you use your TV.

Retain instructions

Retain safety and operating instructions for future reference.

Follow warnings and instructions

Follow all warnings on your TV and in the operating instructions. Follow all operating and use instructions.

Water and moisture

Do not use your TV near water. For example, do not use it near a bath tub, wash bowl, kitchen sink, or laundry tub, in a wet basement, or near a swimming pool.

Cleaning

Unplug your TV before cleaning. Do not use liquid or aerosol cleaners. Use only a damp cloth to clean the exterior of your TV.

Note

If your TV requires uninterrupted service for some specific reason, such as the possibility of the loss of an authorization code for a CATV converter, ignore the instruction to unplug your TV before cleaning.

Ventilation

Slots and openings in the cabinet and the back or bottom are provided for ventilation, reliable operation, and protection from overheating. These openings must not be blocked or covered. Do not block the openings by placing your TV on a bed, sofa, rug, or other similar surface. Do not place your TV near or over a radiator or heat register. Do not place your TV in a built-in installation, such as a bookcase or rack, unless you provide correct ventilation or follow the manufacturer's instructions.

Heat

Make sure that your TV is located away from heat sources such as radiators, heat registers, stoves, or other products (including amplifiers) that produce heat.

Grounding or polarization

Do not defeat the safety purpose of the polarized or grounding-type plug. A polarized plug has two blades with one wider than the other. A grounding type plug has two blades and a grounding prong. The wide blade or grounding prong are provided for your safety. If the plug does not fit, contact an electrician to replace the obsolete outlet.

Power cord protection

Route power cords so that they are not likely to be walked on or pinched by items placed on or against them. Pay particular attention to cords at plugs, convenience receptacles, and the point where they exit from your TV.

Attachments

Do not use attachments not recommended by Insignia because they may cause hazards.

Stand

Do not place your TV on an unstable cart, stand, tripod, bracket, or table. Your TV may fall, causing serious personal injury and serious damage to your TV. Use only with a cart, stand, tripod, bracket, or table recommended by the manufacturer, or sold with your TV. If you mount your TV to the wall, follow the manufacturer's instructions and use a mounting accessory recommended by the manufacturer. Your TV and cart combination should be moved with care. Quick stops, excessive force, and uneven surfaces may cause your TV and cart combination to overturn.



Servicing

Do not attempt to service your TV yourself because opening or removing covers may expose you to dangerous voltage or other hazards. Refer all servicing to qualified service personnel.

Overloading

Do not overload power outlets and extension cords because this can result in a risk of fire or electric shock.

Object and liquid entry

Never push objects of any kind into your TV through openings because objects may touch dangerous voltage points or short out parts that could result in a fire or electric shock. Never spill liquid of any kind on your TV.

Damage requiring service

Unplug this TV from the power outlet and refer servicing to qualified service personnel under the following conditions:

- When the power supply cord or plug is damaged or frayed.
- If liquid has been spilled or objects have fallen into your TV.

- If your TV has been exposed to rain or water.
- If your TV does not operate normally by following the operating instructions. Adjust only those controls that are covered by the operating instructions because incorrect adjustment of other controls may result in damage and will often require extensive work by a qualified technician to restore your TV to its normal operation.
- If your TV has been dropped or damaged in any way.
- When your TV exhibits a distinct change in performance.

Replacement parts

When replacement parts are required, make sure that the service technician uses replacement parts specified by the manufacturer that have the same characteristics as the original part. Unauthorized substitutions may result in fire, electric shock, personal injury, or other hazards.

Safety check

After completing any service or repair to this TV, ask the service technician to perform routine safety checks to determine that your TV is in correct operating condition.

Power source

Operate your TV only from the type of power source indicated on the marking label. If you are not sure of the type of power supplied to your home, consult your TV dealer or local power company.

Lightning

For added protection for your TV's receiver during a lightning storm, or when it is left unattended and unused for long periods of time, unplug it from the power outlet and disconnect the antenna or cable system. This helps prevent damage to your TV from lightning and power line surges.

Screen protection

Your TV's screen is made of glass. Do not drop your TV or hit the glass screen. If the screen breaks, be careful of broken glass.

Pixel defect

Your TV's screen is designed to display finely detailed pictures. Occasionally, a few non-active pixels may appear on the screen as fixed points of blue, green, or red. This is not a defect and does not affect your TV's performance.

Power lines

An outside antenna system should not be located in the vicinity of overhead power lines or other electric light or power circuits, or where it can fall into such power lines or circuits.

When installing an outside antenna system, extreme care should be taken to keep from touching such power lines or circuits as contact with them might be fatal.

Temperature

Do not use in hot or cold locations. If you use your TV in a cold location, the picture may leave trails or appear slightly delayed. This is not a malfunction. Your TV will return to normal operation when the temperature returns to normal.

Do not leave your TV in a hot or cold location. Do not install your TV in a location that is exposed to direct sunlight or near a heater. The cabinet may warp and the screen may malfunction.

Storage temperature: 32°F to 122°F (0°C to 50°C)

Operating temperature: 41°F to 104°F (5°C to 40°C)

After Image

If you display a fixed image on the screen for an extended amount of time, a permanent after image may be burned into the screen. To avoid this type of damage:

- Reduce the brightness and contrast settings to a minimum viewing level.
- Do not display a fixed image for an extended period of time. Examples of fixed images include logos, video games, computer images, teletext, and images displayed in 4:3 mode. This type of damage is not covered by your warranty.
- Turn off your TV when it is not in use

Outdoor antenna grounding

If an outside antenna or cable system is connected to your TV, make sure that the antenna or cable system is grounded to provide some protection against voltage surges and built-up static charges. Article 810 of the National Electrical Code, ANSI/NFPA No. 70, provides information with respect to correct grounding of the mast and supporting structure, grounding of the lead-in wire to an antenna discharge unit, size of grounding conductors, location of the antenna-discharge unit, connection to grounding electrodes, and requirements for the grounding electrode.

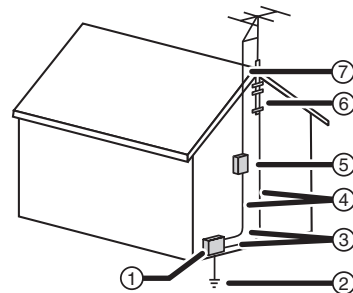

1	Electric service equipment
2	Power service grounding electrode system
3	Ground clamps
4	Grounding conductors
5	Antenna discharge unit
6	Grounding clamp
7	Antenna lead-in wire

Note to CATV system installer

This reminder is provided to call the CATV system installer's attention to Article 820-40 of the NEC that provides guidelines for correct grounding and in particular, specifies that the cable ground must be connected to the grounding system of the building as close to the point of cable entry as practical.

Features

Front

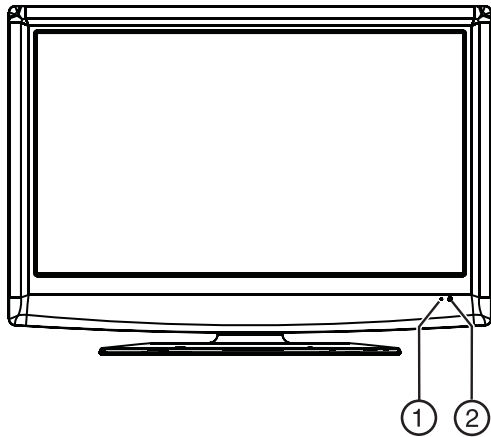

#	Component	Description
1	Power indicator	Lights blue when your TV is turned on. Lights red when your TV is in standby mode.
2	Remote control sensor	Receives signals from the remote control. Do not block.

Right side buttons

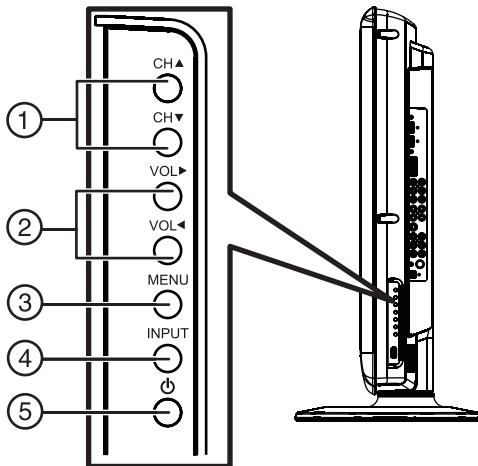

#	Button	Description
1	CH▲/CH▼	Press to go to the next or previous channel in the channel list.
2	VOL▶/VOL◀	Press to increase or decrease the volume.
3	MENU	Press to open the on-screen menu.
4	INPUT	Press to select the video input. For more information, see "Selecting the video input source" on page 11.
5	⏻ (power)	Press to turn your TV on or off. When you turn off your TV, it goes into standby mode.

Right side jacks

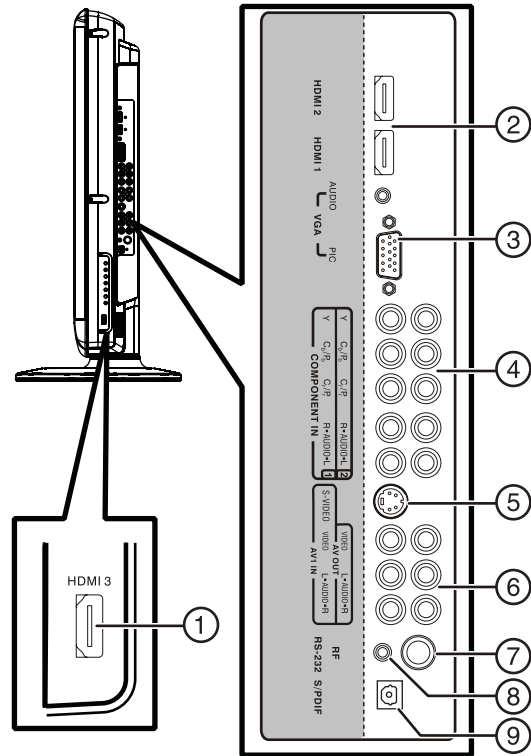

#	Jack	Description
1	HDMI 3	Connect an HDMI device to this jack.
2	HDMI 1/HDMI 2	Connect HDMI devices to this jack.
3	VGA PIC/AUDIO	Connect a computer to these jacks.
4	COMPONENT IN1 COMPONENT IN 2	Connect component video devices to these jacks.
5	S-VIDEO/AV1 INPUT	Connect an S-Video or AV device to one of these video jacks, then connect the audio to the adjacent audio jacks.
6	AV OUT	Connect a VCR for recording to these jacks.
7	RF	Connect an antenna or cable TV to this jack.
8	RS-232	For service only. Do not use.
9	S/PDIF OUT	Connect to a digital audio system.

Left side

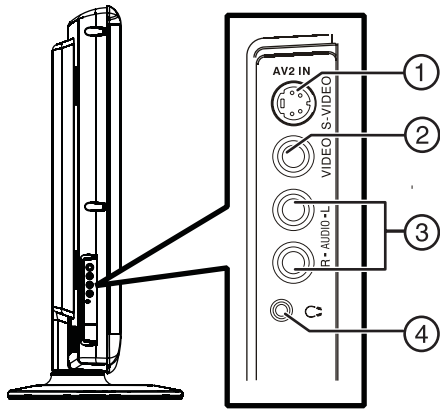

#	Component	Description
1	AV2 IN/S-VIDEO	Connect an S-Video device to this jack.
2	AV2 IN-VIDEO	Connect an AV device to this jack.
3	AUDIO-R/AUDIO-L	Connect the audio for the S-Video device or AV device connected to the AV2 video jacks.
4	Headphone	Connect headphones to this jack.

Remote control

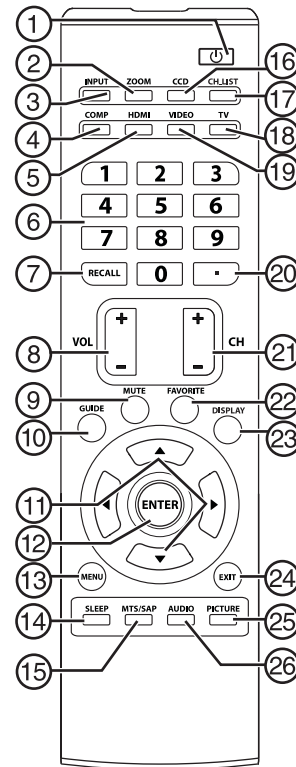

#	Button	Description
1	⏻ (Power)	Press to turn on your TV. Press again to put your TV in Standby mode.
2	ZOOM	Press to select the aspect ratio. You can select Normal , Wide , Zoom , or Cinema . For more information, see "Selecting the aspect ratio" on page 16.
3	INPUT	Press to open the <i>INPUT SOURCE</i> menu, then press ▲ or ▼ to select the video input source. You can select TV , AV1 , AV2 , S-Video1 , S-Video2 , Component1 , Component2 , HDMI1 , HDMI2 , HDMI3 , or VGA .
4	COMP	Press once to select the device connected to the COMPONENT1 jacks. Press twice to select the device connected to the COMPONENT2 jacks.
5	HDMI	Press once to select the device connected the HDMI1 jack. Press twice to select the device connected to the HDMI2 jack. Press three times to select the device connected to the HDMI3 jack.
6	Numbers	Press to enter channel numbers or the parental control password.
7	RECALL	Press to go to the last viewed channel.
8	VOL+/VOL-	Press to increase or decrease the volume.
9	MUTE	Press to turn off the sound. Press again to turn on the sound.
10	GUIDE	Press to open the DTV program guide (if available). For more information, see "Displaying the DTV program guide" on page 20.

#	Button	Description
11	▲ ▼ ▶ ◀	Press to navigate in on-screen menus.
12	ENTER	Press to confirm selections in an on-screen menu or to open a submenu.
13	MENU	Press to open the on-screen menu.
14	SLEEP	Press to set the sleep timer. For more information, see "Setting the sleep timer" on page 16.
15	MTS/SAP	Press to select the audio mode. For analog channels, you can select STEREO , SAP (secondary audio program), or MONO . For digital channels, you can select the audio track (if more than one track is available). For more information, see "Selecting the audio mode" on page 15.
16	CCD	Press to turn closed captioning on or off. For more information, see "Turning closed captioning on or off" on page 17 or "Selecting the closed captioning mode" on page 17.
17	CH.LIST	Press to open the channel list. For more information, see "Changing channels" on page 13.
18	TV	Press to watch TV channels.
19	VIDEO	Press once to select a device connected to the AV1 jacks. Press twice to select a device connected to the AV2 jacks. Press three times to select a device connected to the S-VIDEO1 jack. Press four times to select a device connected to the S-VIDEO2 jack. For more information, see "Selecting the video input source" on page 11.
20	●	Press to select a digital sub-channel. For more information, see "Changing channels" on page 13.
21	CH+/CH-	Press to go to the next or previous channel in the channel list. For more information, see "Changing channels" on page 13.
22	FAVORITE	Press to display the favorite channel list. For more information, see "Setting up the favorite channel list" on page 18.
23	DISPLAY	Press to display the information banner. For more information, see "Displaying the information banner" on page 20.
24	EXIT	Press to close the on-screen menu.
25	PICTURE	Press to select the picture mode. You can select Standard , Dynamic , Soft , or Personal . For more information, see "Adjusting the picture" on page 14.
26	AUDIO	Press to select the sound mode. You can select Standard , Music , Movie , or Personal . For more information, see "Adjusting the sound" on page 15.

Setting up your TV

Installing remote control batteries

To install remote control batteries:

- 1 Open the battery compartment cover.
- 2 Insert two AAA batteries into the battery compartment. Make sure that the + and – symbols on the batteries match the + and – symbols in the battery compartment.

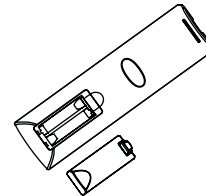

- 3 Replace the cover.

Notes

- Do not mix different types of batteries.
- Do not mix old and new batteries.
- Remove batteries when they no longer have a charge. Chemicals may leak into the battery compartment. Battery chemicals can cause a rash. If chemicals leak, clean the battery compartment with a cloth.
- Remove the batteries if you do not intend to use the remote control for an extended amount of time.
- Do not dispose of batteries in a fire. Dispose of them as hazardous waste.

Connecting an antenna, cable TV, or satellite TV box

To connect an antenna, cable TV, or satellite TV box:

- 1 Make sure that your TV's power cord is unplugged.
- 2 Connect a 75 ohm coaxial cable to the RF jack on the right side of your TV, then connect the other end of the cable to the antenna, cable TV, or satellite TV box.

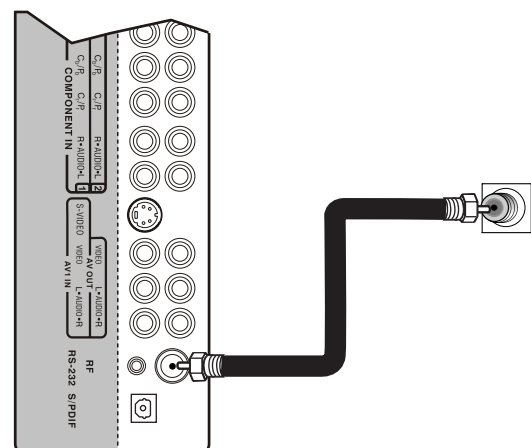

Connecting an HDMI device

Your TV has three HDMI jacks on the right side. For the location of the jacks, see “Right side jacks” on page 5.

To connect an HDMI device:

- 1 Make sure that your TV's power cord is unplugged and the HDMI device is turned off.
- 2 Connect an HDMI cable to the **HDMI 1**, **HDMI 2**, or **HDMI 3** jack on the right side of your TV, then connect the other end of the cable to the **HDMI OUT** jack on the HDMI device.

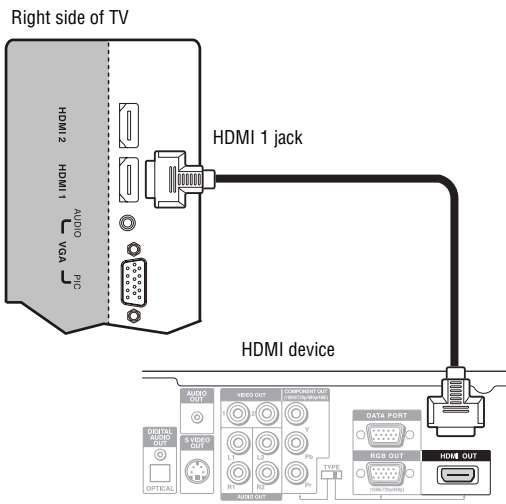

To play from the HDMI device:

- 1 Turn on your TV, then press **INPUT**. The **INPUT SOURCE** menu opens.
- 2 Press **▲** or **▼** to select **HDMI1**, **HDMI2**, or **HDMI3**, then press **ENTER**.

Note

You can also press **HDMI** once for **HDMI1**, twice for **HDMI2**, or three times for **HDMI3**.

- 3 Turn on the HDMI device, and set it to the correct output mode. See the HDMI device's user guide for more information.

Note

If the external device has DVI output only, use a DVI-to-HDMI adapter to connect to the **HDMI** jack, then connect an audio cable to the **VGA AUDIO** jack.

Connecting a component video device

Your TV has two sets of component video jacks on the right side. For the location of the jacks, see “Right side jacks” on page 5.

To connect a component video device:

- 1 Make sure that your TV's power cord is unplugged and the component video device is turned off.
- 2 Connect a component video cable to the **COMPONENT 1** or **COMPONENT 2** jacks on the right side of your TV, then connect the other end of the cable to the **COMPONENT OUT** jack on the component video device.

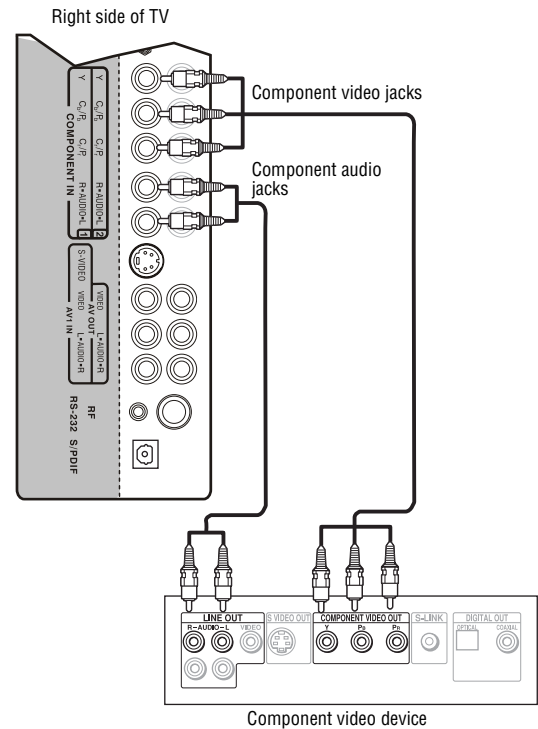

- 3 Connect an audio cable to the **COMPONENT 1 AUDIO** or **COMPONENT 2 AUDIO** jacks on the right side of your TV.

To play from a component device:

- 1 Turn on your TV, then press **INPUT**. The **INPUT SOURCE** menu opens.
- 2 Press **▲** or **▼** to select **Component1** or **Component2**, then press **ENTER**.

Note

You can also press **COMP** once for **Component1** or twice for **Component2**.

- 3 Turn on the component video device, and set it to the correct output mode. See the component video device's user guide for more information.

Connecting a VCR for playback

You can connect a VCR to the AV or S-Video jack. Your TV has two AV video and two S-Video jacks. For the location of the jacks, see "Right side jacks" on page 5 or "Left side" on page 6. The following task shows how to connect a VCR to the right-side jacks.

To connect a VCR for playback:

- 1 Make sure that your TV's power cord is unplugged and the VCR is turned off.
- 2 Connect an AV video cable to the **AV1 IN VIDEO** jack on the right side of your TV.

Or, connect an S-Video cable to the **AV1 IN S-VIDEO** jack on the right side of your TV.

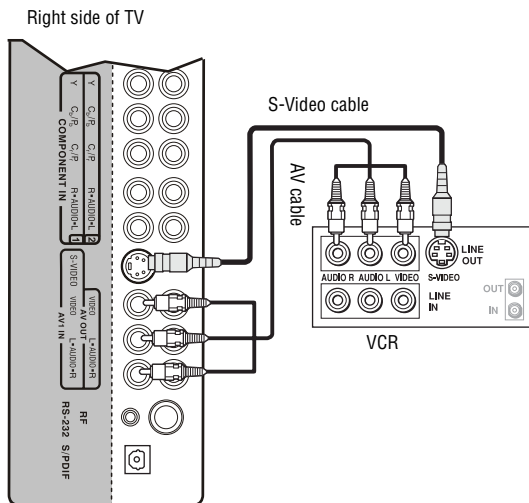

- 3 Connect the audio plugs on the AV cable to the **AV1 IN AUDIO-L** and **AUDIO-R** jacks on the right side of your TV.

To play from the VCR:

- 1 Turn on your TV, then press **INPUT**. The **INPUT SOURCE** menu opens.
- 2 Press **▲** or **▼** to select **AV1** or **S-Video1**, then press **ENTER**.

Note

You can also press **VIDEO** one or more times to select **AV1** or **S-Video1**.

- 3 Turn on the VCR, insert a videotape, then press **PLAY** on the VCR.

Connecting a VCR for recording

To connect a VCR for recording:

- 1 Make sure that your TV's power cord is unplugged and the VCR is turned off.
- 2 Connect an AV cable to the **AV OUT VIDEO** and **AV OUT AUDIO-L** and **AUDIO-R** jacks on the right side of your TV, then connect the other end of the cable to the **AV IN** jacks on the VCR.

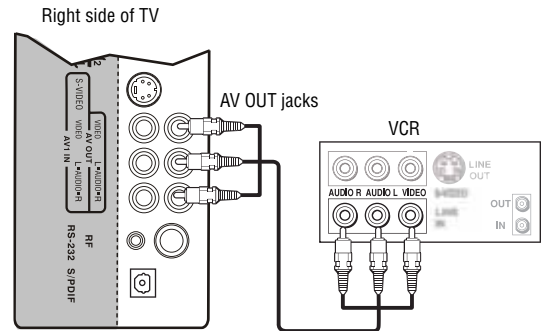

To record to a VCR:

- 1 Turn on your TV, then select the program you want to record.
- 2 Turn on the VCR, insert a videotape, then press **RECORD** on the VCR.

Note

You can record analog TV programs and output from the **AV OUT** jacks only.

Connecting a camcorder or game

Your TV has two AV jacks. For the location of the jacks, see "Right side jacks" on page 5 or "Left side" on page 6.

The following task shows how to connect a camcorder or game to the left-side jacks.

To connect a camcorder or game:

- 1 Make sure that your TV's power cord is unplugged and the camcorder or game is turned off.
- 2 Connect an AV cable to the **AV2 IN VIDEO** and **AV2 AUDIO-L** and **AUDIO-R** jacks on the left side of your TV, then connect the other end of the cable to the AV OUT jacks on the camcorder or game.

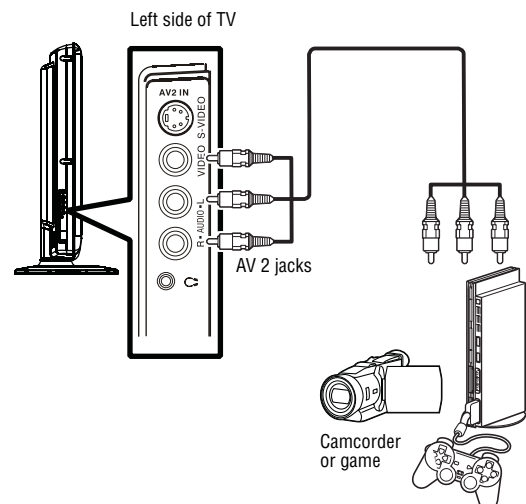

Connecting a computer

To connect a computer:

- 1 Make sure that your TV's power cord is unplugged and the computer is turned off.
- 2 Connect a VGA cable to the **VGA PIC** jack on the right side of your TV, then connect the other end of the cable to the **VGA** jack on the computer.

Note

The VGA cable should be a 15-pin D-Sub cable (analog RGB).

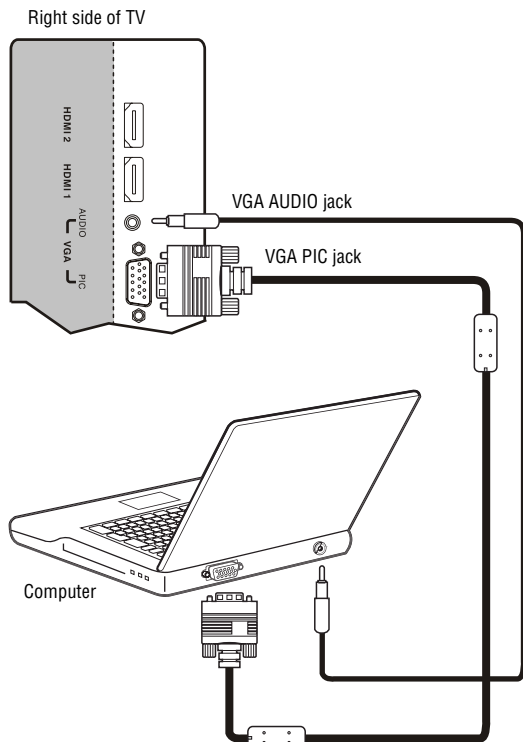

- 3 Connect an audio cable to the **VGA AUDIO** jack on the right side of your TV, then connect the other end of the cable to the **AUDIO OUT** jack on the computer.

Note

The audio cable should have stereo mini plugs.

To play video from a computer:

- 1 Turn on your TV, then press **INPUT**. The **INPUT SOURCE** menu opens.
- 2 Press **▲** or **▼** to select **VGA**, then press **ENTER**.
- 3 Turn on the computer, then adjust the display properties, if necessary.

Connecting a digital sound system

To connect a digital sound system:

- 1 Make sure that your TV's power cord is unplugged and the digital sound system is turned off.
- 2 Connect a digital optical audio cable to the **S/PDIF** jack on right side of your TV, then connect the other end of the cable to the **S/PDIF IN** jack on the digital sound system.

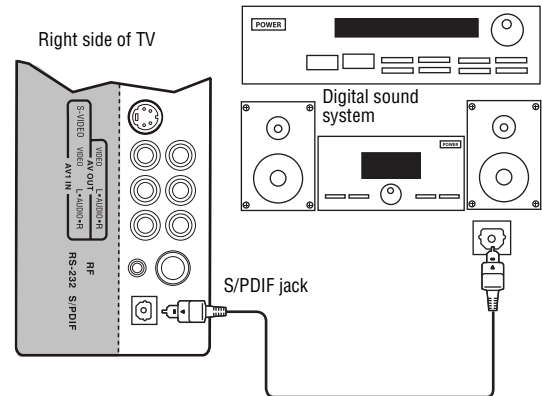

Note

The **S/PDIF** jack works with digital TV channels only.

Connecting headphones

To connect headphones:

- Connect the headphones to the headphone jack on the left side of your TV.

Note

Loud noise can damage your hearing. When using headphones, use the lowest volume setting that still lets you hear the sound.

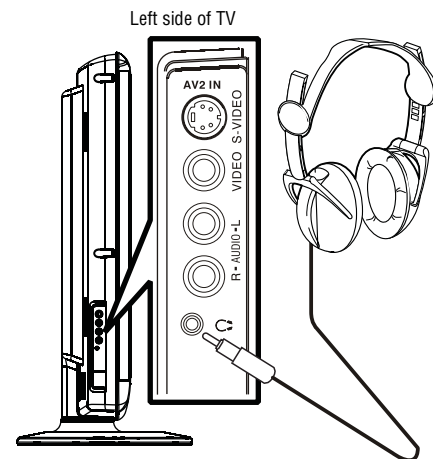

Connecting the power cord

To connect the power cord:

- Plug the power cord into the **AC IN** jack on the back of your TV, then plug the other end into a power outlet.

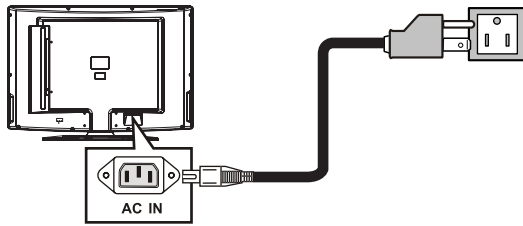

Using your TV

Turning your TV on or off

To turn your TV on or off (standby mode):

- 1 Plug the power cord into a power outlet.
- 2 Press **⏻** (power). Your TV turns on.
- 3 Press **⏻** again to turn off your TV. When you turn off your TV, it goes into standby mode.

Warning

When your TV is in standby mode, it is still receiving power. To completely disconnect power, unplug the power cord.

Note

If your TV does not receive an input signal for several minutes, it automatically goes into standby mode.

Using the remote control

- Point the remote control toward the remote control sensor on the front of your TV.
- Make sure that no objects are between the remote control and the remote control sensor.
- Do not expose the remote control to shock.
- Do not expose the remote control to liquids or high humidity.
- Do not place your TV in a location where sunlight or bright light shines on the remote control sensor. This can interfere with the signal from the remote control.

The following illustration shows the best angle for using the remote control.

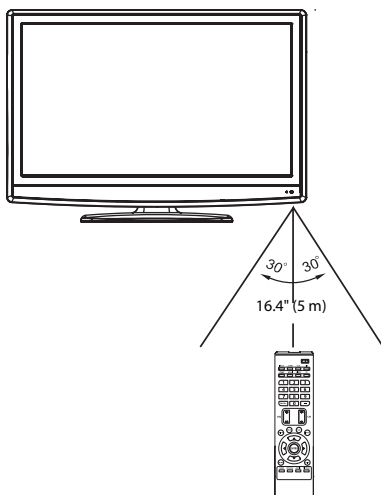

Selecting the video input source

To select the video input source:

- 1 Turn on your TV, then press **INPUT**. The **INPUT SOURCE** menu opens.

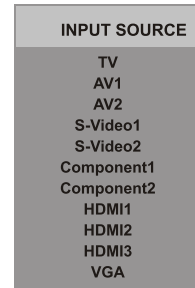

- 2 Press **▲** or **▼** to select the video source, then press **ENTER**. You can select:

- **TV**
- **AV1**
- **AV2**
- **S-Video1**
- **S-Video2**
- **Component1**
- **Component2**
- **HDMI1**
- **HDMI2**
- **HDMI3**
- **VGA**

You can also select the input source using the following remote control buttons:

- **COMP**—Press once to select **Component1**. Press twice to select **Component2**.
- **HDMI**—Press once to select **HDMI1**. Press twice to select **HDMI2**. Press three times for **HDMI3**.
- **VIDEO**—Press once to select **AV1**. Press twice to select **AV2**. Press three times for **S-Video1**. Press four times for **S-Video2**.
- **TV**—Press to select **TV**.

Selecting the TV signal source

The first time you turn on your TV, you must select the TV signal source. Your TV stores this information.

You do not need to change the TV signal source unless it changes. For example, you change from an outside antenna to cable TV.

To select the TV signal source:

- 1 Press **MENU**. The on-screen menu opens.

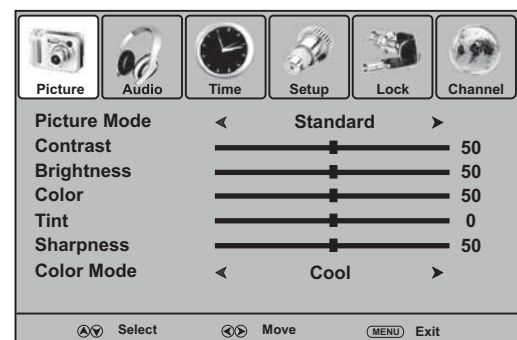

- Press **◀** or **▶** to select **Channel**, then press **▼**. The *Channel* menu opens.

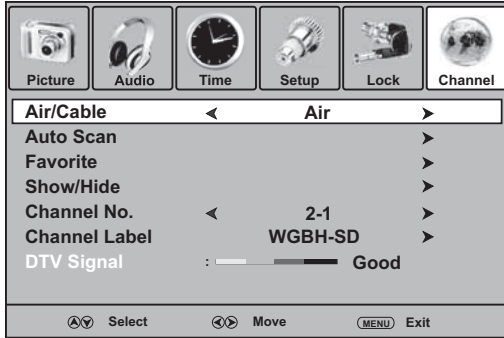

- Press **▲** or **▼** to highlight **Air/Cable**, then press **◀** or **▶** to select **Air** (antenna) or **Cable** (cable or satellite TV).
- Press **EXIT** to close the menu.

Scanning for channels

The first time you turn on your TV, you need to scan for channels available in your area. Your TV skips any channel that does not have a signal. Your TV stores the channel information in the channel list. When you press **CH+** or **CH-**, your TV tunes to the next or previous stored channel. You do not need to scan for channels again unless:

- You change the TV signal input source. For example, you change from an antenna to cable TV.
- More channels become available.
- You move your TV to a different viewing area.

To scan for channels when the TV signal source is Antenna:

- Make sure that you have selected the TV signal source. For more information, see "Selecting the TV signal source" on page 11.
- Press **MENU**. The on-screen menu opens.

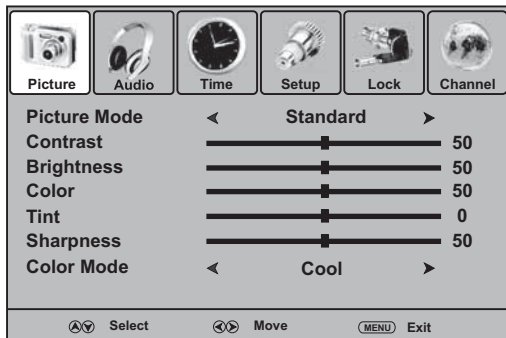

- Press **◀** or **▶** to select **Channel**, then press **▼**. The *Channel* menu opens.

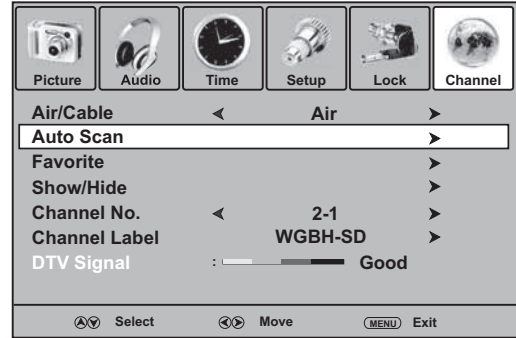

- Press **▲** or **▼** to highlight **Auto Scan**, then press **▶** or **ENTER**. **Start to Scan** is highlighted.
- Press **▶** or **ENTER** to start the scan. Your TV scans for analog and digital channels and stores the channel information in the channel list.

To scan for channels when the TV signal source is Cable:

- Make sure that you have selected the TV signal source. For more information, see "Selecting the TV signal source" on page 11.
- Press **MENU**. The on-screen menu opens.

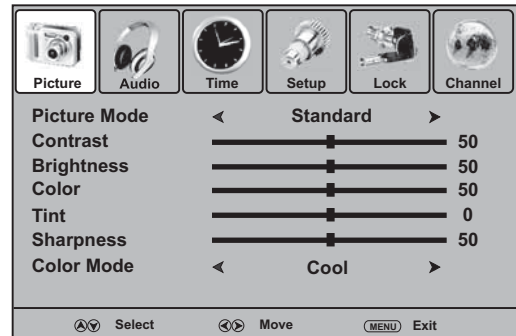

- Press **◀** or **▶** to select **Channel**, then press **▼**. The *Channel* menu opens.



- Press **▲** or **▼** to highlight **Auto Scan**, then press **▶** or **ENTER**.

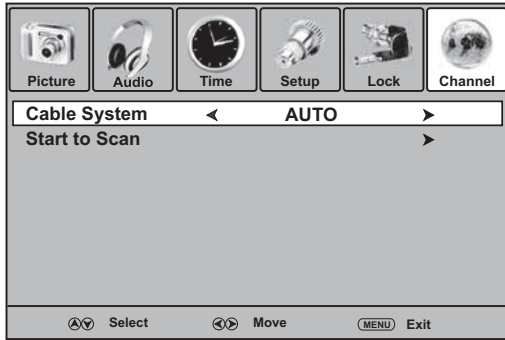

- Press **▲** or **▼** to highlight **Cable System**, then press **◀** or **▶** to select the type of cable system you have. You can select **STD**, **IRC**, **HRC**, or **AUTO**. If you do not know the type of cable system, select **AUTO**.
- Press **▲** or **▼** to highlight **Start to Scan**, then press **▶** or **ENTER** to start the scan. Your TV scans for analog and digital cable channels and stores the channel information in the channel list.

Note
If you want to stop the scan, press **MENU**.

Deleting channels

You can delete a channel from the channel list so your TV skips the channel when you press **CH+** or **CH-**. You can still tune to the channel using the number buttons.

To delete a channel:

- Press **MENU**. The on-screen menu opens.

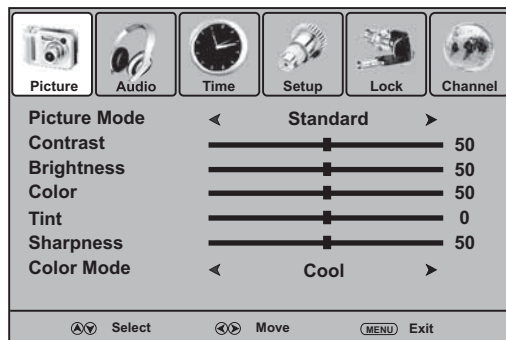

- Press **◀** or **▶** to select **Channel**, then press **▼**. The *Channel* menu opens.

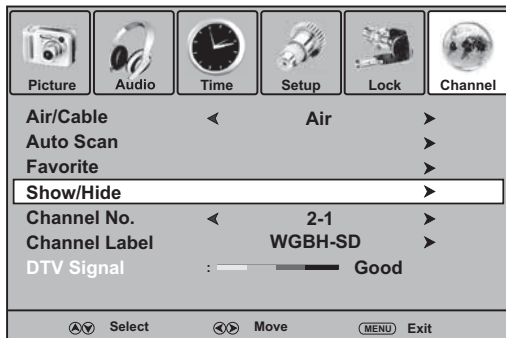

- Press **▲** or **▼** to highlight **Show/Hide**, then press **▶** or **ENTER**. The channel list opens.

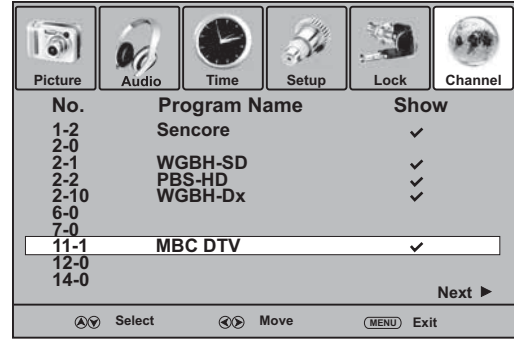

- Press **▲** or **▼** to highlight the channel you want to delete, then press **ENTER** to mark the channel. A check mark disappears if the channel is deleted. The check mark appears if you add back the channel.

Note
If the list has more than one page, press **◀** or **▶** to scroll through the pages.

- Press **EXIT** to close the menu.

Changing channels

Some digital channels may have sub-channels. The main digital channel broadcasts the program. A sub-channel may broadcast a variety of information depending on the broadcaster. For example, a sub-channel may broadcast a second language, weather forecast, or advertising.

To change channels:

- Press **CH+** or **CH-** to tune to the next or previous channel in the channel list.
 - Press the number buttons for the channel you want, then press **ENTER** to tune to the channel immediately or wait a few seconds for the channel to change automatically.
- If you want to tune to a digital sub-channel, press the number buttons for the main channel, press **●**, then press the number button for the sub-channel. For example, to tune to sub-channel 3 of main channel 8, press **8**, press **●**, then press **3**. Button presses must be within two seconds of each other.
- Press **RECALL** to tune to the last viewed channel.
 - Press **CH.LIST** to open the channel list, press **▲** or **▼** to highlight a channel, then press **ENTER**.
 - Press **FAVORITE** to open the favorite list, press **▲** or **▼** to highlight a channel, then press **ENTER**.

Adjusting the volume

To adjust the volume:

- Press **VOL+** or **VOL-** to increase or decrease the volume.
- Press **MUTE** to turn off the sound. Press this button again to turn the sound back on.

Adjusting the picture

To adjust the picture:

- 1 Press **MENU**. The on-screen menu opens.

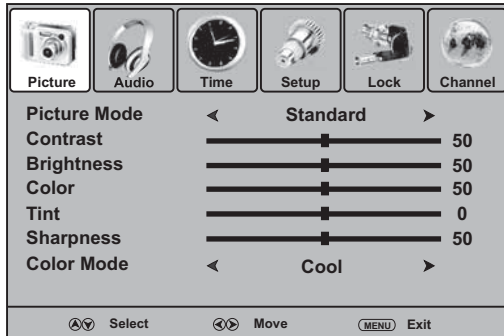

- 2 Press **◀** or **▶** to select **Picture**, then press **▼**. The *Picture* menu opens.

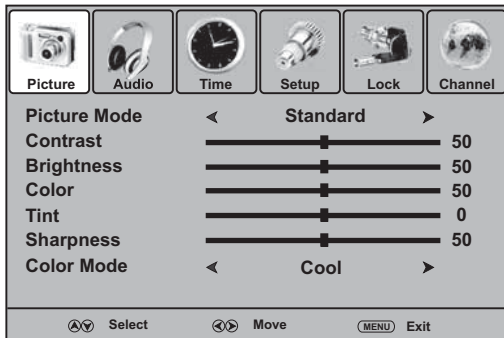

- 3 Press **▲** or **▼** to select an option, then press **◀** or **▶** to adjust the option. You can select:
 - **Picture mode**—Selects the picture mode. You can select **Standard** (standard picture), **Dynamic** (bright, vivid picture), **Soft** (finely detailed picture), or **Personal** (customized picture). You can also press **PICTURE** to select the picture mode.
 - **Contrast**—Adjusts the contrast.
 - **Brightness**—Adjusts the brightness.
 - **Color**—Adjusts the color saturation.
 - **Tint**—Adjusts the image tint.
 - **Sharpness**—Adjusts the sharpness.
 - **Color Mode**—Selects the color temperature. You can select **Warm** (enhances “hotter” colors such as red), **Cool** (softens the colors and adds more blue), or **Normal** (does not adjust the colors).
- 4 Press **MENU** to return to the previous menu, or press **EXIT** to close the menu.

Reducing video noise (snow)

To reduce video noise (snow):

- 1 Press **MENU**. The on-screen menu opens.

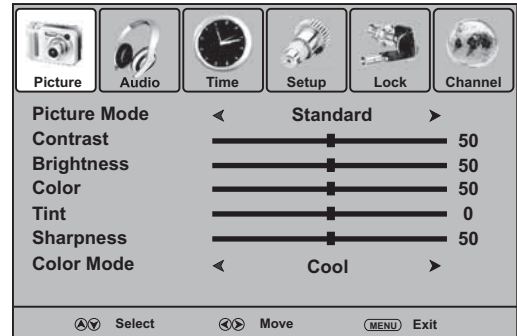

- 2 Press **◀** or **▶** to select **Setup**, then press **▼**. The *Setup* menu opens.

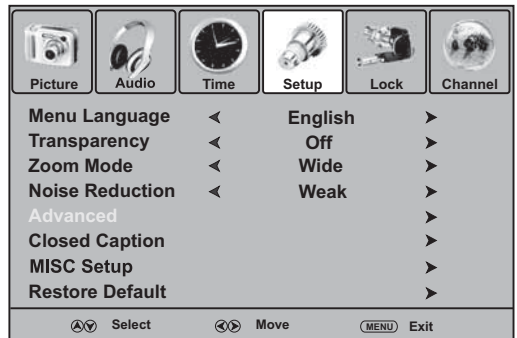

- 3 Press **▲** or **▼** to highlight **Noise Reduction**, then press **◀** or **▶** to select an option. You can select **Weak**, **Middle**, or **Strong**. To turn off noise reduction, select **Off**.
- 4 Press **MENU** to return to the previous menu, or press **EXIT** to close the menu.

Optimizing the picture

If the picture appears pale or dim, you can optimize the picture to make the colors more vivid.

To optimize the picture:

- 1 Press **MENU**. The on-screen menu opens.

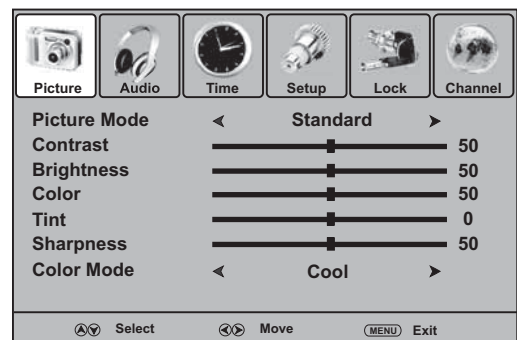

- Press **◀** or **▶** to select **Setup**, then press **▼**. The *Setup* menu opens.

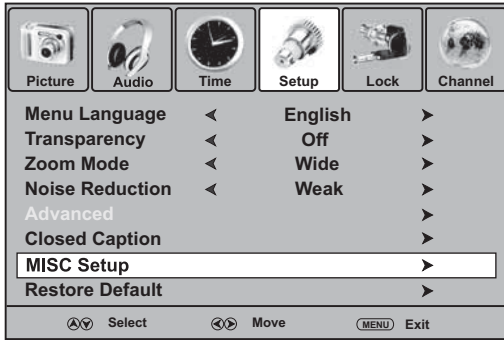

- Press **▲** or **▼** to highlight **MISC Setup**, then press **▶** or **ENTER**.

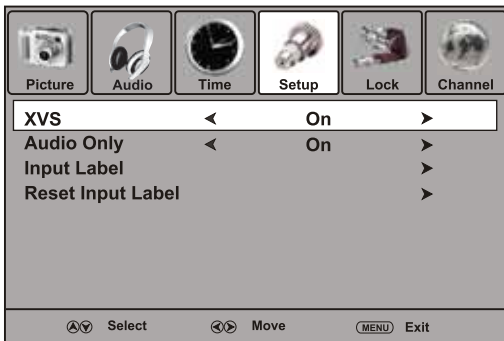

- Press **▲** or **▼** to highlight **XVS**, then press **◀** or **▶** to select **On** or **Off**. The picture becomes more vivid.
- Press **MENU** to return to the previous menu, or press **EXIT** to close the menu.

Adjusting the sound

To adjust the sound:

- Press **MENU**. The on-screen menu opens.

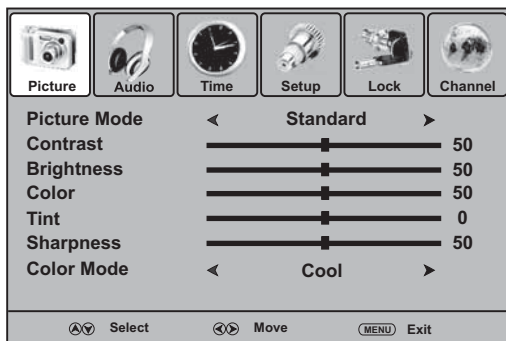

- Press **◀** or **▶** to select **Audio**, then press **▼**. The *Audio* menu opens.

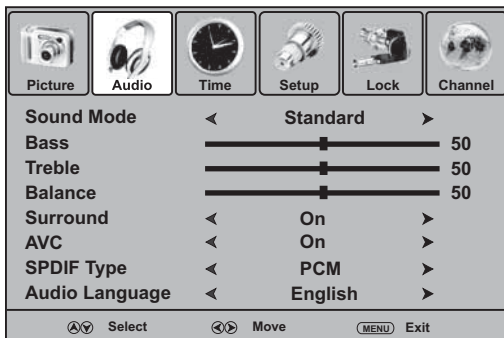

- Press **▲** or **▼** to select an option, then press **◀** or **▶** to adjust the option. You can select:

- Sound Mode**—Selects the sound mode. You can select **Standard** (for normal programs), **Music** (for musical programs), **Movie** (for movies), or **Personal** (for a customized sound mode).
- Bass**—Adjusts the low sounds.
- Treble**—Adjusts the high sounds.
- Balance**—Adjusts the balance between the left and right audio channels.
- Surround**—Turns the surround sound effect on or off.
- AVC**—(Auto volume control) Equalizes the overall volume levels for all channels.
- SPDIF Type**—(DTV channels only) Selects the S/PDIF audio output mode. You can select **RAW** (outputs audio in its original format) or **PCM** (outputs the audio in PCM mode, if available).
- Audio Language**—(DTV channels only) Selects an alternate audio language, if available.

- Press **MENU** to return to the previous menu, or press **EXIT** to close the menu.

Selecting the audio mode

You can select the audio mode for analog channels or you can select an audio track for digital channels, if available.

To select the audio mode for analog channels:

- Press **MTS/SAP** one or more times. You can select:
 - MONO**—Select this option if there is noise or static on weak stereo broadcasts.
 - STEREO**—Select this option for programs broadcast in stereo.
 - SAP**—Select this option to listen to a secondary audio program, if available.

Note

Mono is automatically selected if the program is broadcast in mono.

To select an audio track for a digital channel:

- Press **MTS/SAP**. If an audio track is available, it plays.

Setting the clock

Your TV sets the time based on time information from a digital channel.

To set the clock:

- Press **MENU**. The on-screen menu opens.

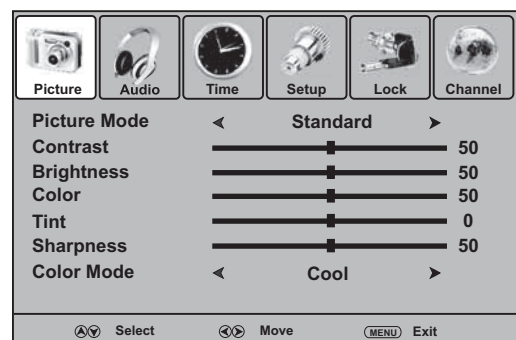

- Press **◀** or **▶** to select **Time**, then press **▼**. The *Time* menu opens.

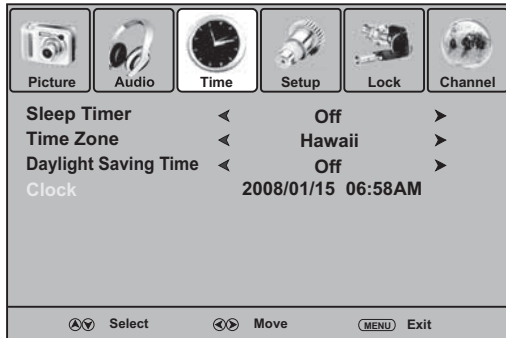

- Press **▲** or **▼** to highlight **Time Zone**, then press **◀** or **▶** to select your time zone. You can select **Pacific, Alaska, Hawaii, Eastern, Central, or Mountain**.
- If your viewing area observes Daylight Saving time, press **▲** or **▼** to highlight **Daylight Saving Time**, then press **◀** or **▶** to select **On**.
The current time appears at the bottom of the option list.
- Press **EXIT** to close the menu.

Setting the sleep timer

You can specify the amount of time you want your TV to wait before it automatically turns off.

To set the sleep timer:

- Press **MENU**. The on-screen menu opens.

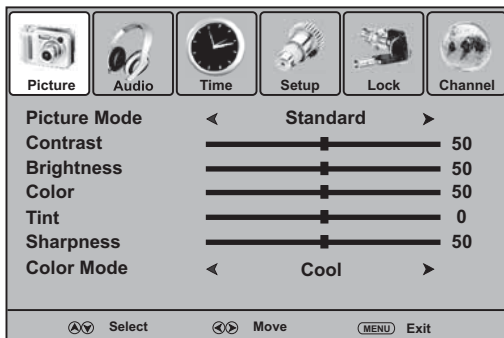

- Press **◀** or **▶** to select **Time**, then press **▼**. The *Time* menu opens.

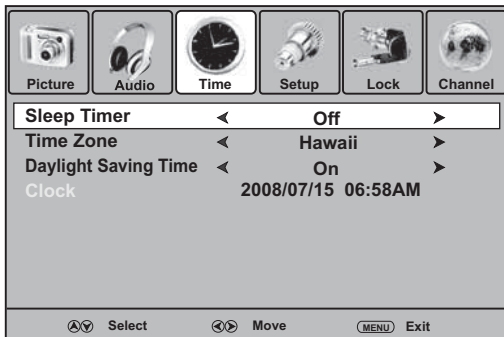

- Press **▲** or **▼** to highlight **Sleep Timer**, then press **◀** or **▶** to select the amount of time you want your TV to wait before it automatically turns off.

Note
To turn off the sleep timer, select **Off**.

- Press **EXIT** to close the menu.

Note
You can also press **SLEEP** to set the sleep timer.

Selecting the aspect ratio

To select the aspect ratio:

- Press **MENU**. The on-screen menu opens.

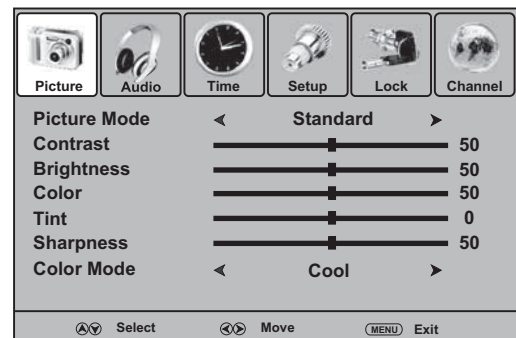

- Press **◀** or **▶** to select **Setup**, then press **▼**. The *Setup* menu opens.

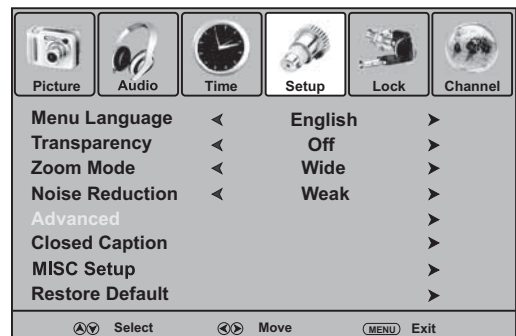

- Press **▲** or **▼** to highlight **Zoom Mode**, then press **◀** or **▶** to select the aspect ratio. You can select:

- Normal**—Selects the aspect ratio to match the video source's image (4:3 or 16:9).
- Wide**—Displays the video image full screen.
- Zoom**—Enlarges the video image. The bottom and top of the image may be cropped.
- Cinema**—Stretches the video image to fill the screen while maintaining a clear image in the middle of the screen.

- Press **EXIT** to close the menu.

Turning closed captioning on or off

To turn closed captioning on or off:

- 1 Press **MENU**. The on-screen menu opens.

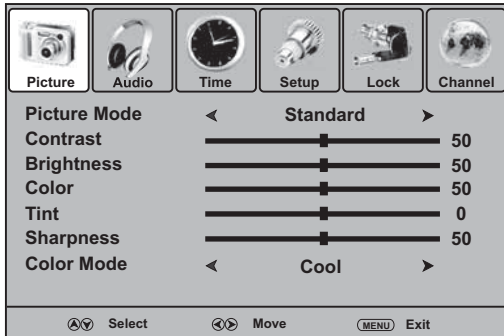

- 2 Press **◀** or **▶** to select **Setup**, then press **▼**. The *Setup* menu opens.

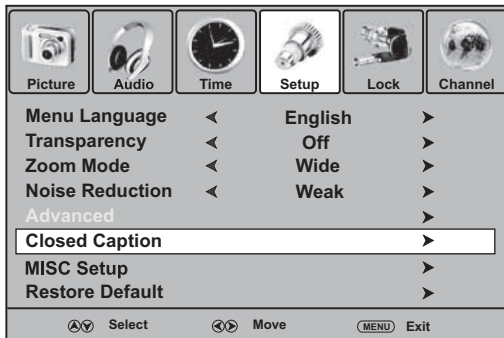

- 3 Press **▲** or **▼** to highlight **Closed Caption**, then press **▶** or **ENTER**. The closed caption menu opens.

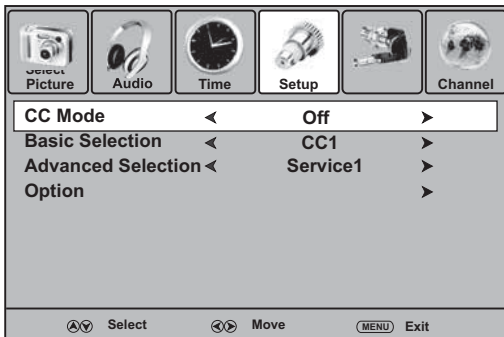

- 4 Press **▲** or **▼** to highlight **CC Mode**, then press **◀** or **▶** to select the CC mode. You can select **On** (turns on closed captioning), **CC on Mute** (turns on closed captioning when the sound is muted), or **Off** (turns off closed captioning).
- 5 Press **EXIT** to close the menu.

Note

You can also press **CCD** to turn closed captioning on or off.

Selecting the closed captioning mode

To select the closed captioning mode:

- 1 Press **MENU**. The on-screen menu opens.

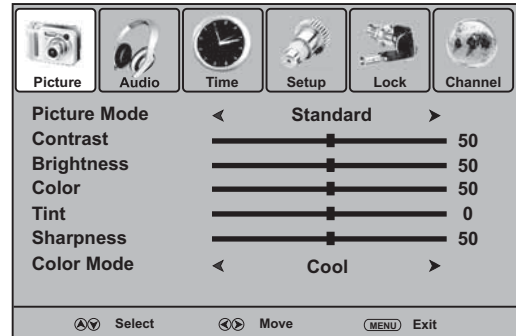

- 2 Press **◀** or **▶** to select **Setup**, then press **▼**. The *Setup* menu opens.

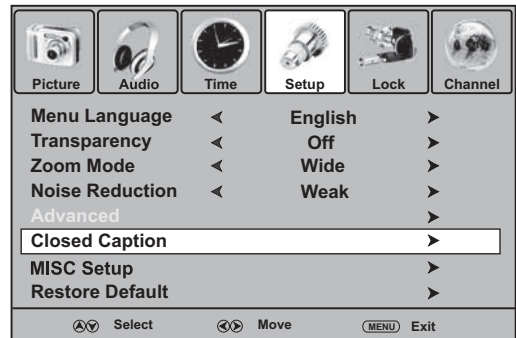

- 3 Press **▲** or **▼** to highlight **Closed Caption**, then press **▶** or **ENTER**. The closed caption menu opens.

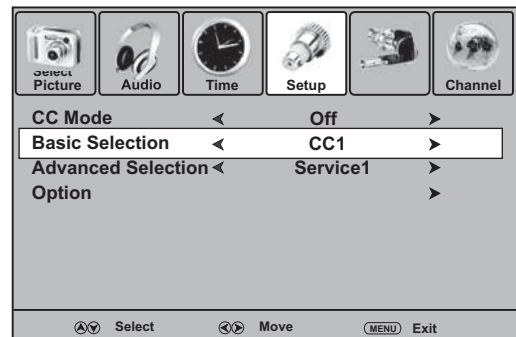

- 4 Press **▲** or **▼** to highlight **Basic Selection**, then press **▶** or **ENTER**.
- 5 Press **◀** or **▶** to select a closed captioning mode. You can select:
 - **CC1** through **CC4**—Closed captioning appears in a small banner across the bottom of the screen. **CC1** is usually the “printed” version of the audio. **CC2** through **CC4** display content provided by the broadcaster.
 - **Text1** through **Text4**—Closed captioning covers half or all of the screen. **Text1** through **Text4** display content provided by the broadcaster.
- 6 Press **▲** or **▼** to highlight **Advanced Selection**, then press **◀** or **▶** to select an option. (DTV only)

Customizing DTV closed captioning styles

You can customize the way DTV closed captioning is displayed.

To customize DTV closed captioning:

- 1 Press **MENU**. The on-screen menu opens.

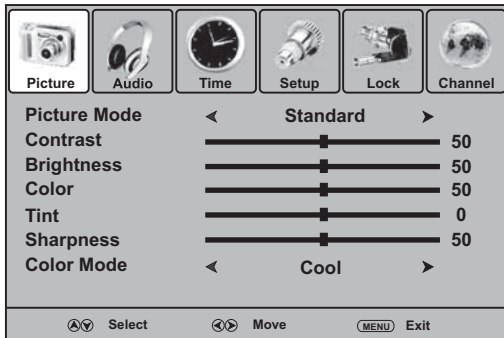

- 2 Press **◀** or **▶** to select **Setup**, then press **▼**. The *Setup* menu opens.

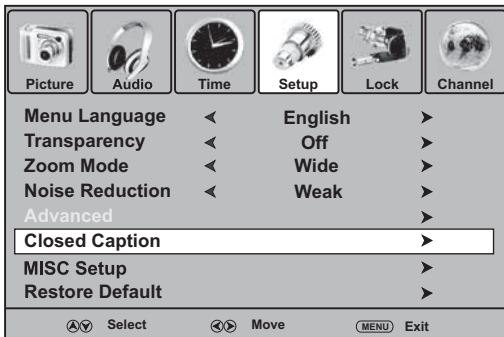

- 3 Press **▲** or **▼** to highlight **Closed Caption**, then press **▶** or **ENTER**. The closed caption menu opens.

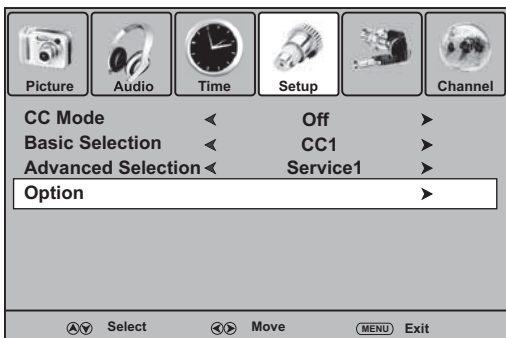

- 4 Press **▲** or **▼** to highlight **Option**, then press **▶** or **ENTER**. The DTV closed captioning styles menu opens.

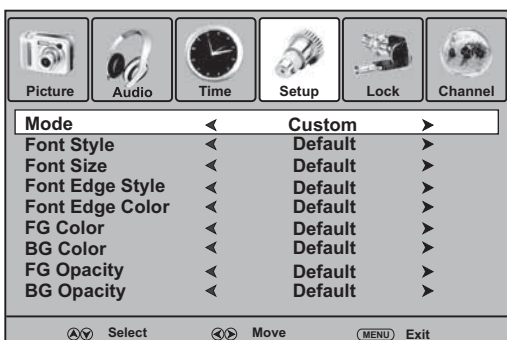

- 5 Press **▲** or **▼** to highlight **Mode**, then press **◀** or **▶** to select **Custom**.

Note

To reset the closed captioning styles to their defaults, set **Mode** to **Default**.

- 6 Press **▲** or **▼** to highlight a style, then press **◀** or **▶** to adjust the style. You can select:
 - **Font Style**—Selects the font style.
 - **Font Size**—Selects the font size.
 - **Font Edge Style**—Selects the edge style.
 - **Font Edge Color**—Selects the edge color.
 - **FG Color**—Selects the color for the words.
 - **BG Color**—Selects the color for the background.
 - **FG Opacity**—Selects the opacity level for the words.
 - **BG Opacity**—Selects the opacity level for the background.
- 7 Press **MENU** to return to the previous menu, or press **EXIT** to close the menu.

Setting up the favorite channel list

You can create a favorite channel list so you can quickly browse through your favorite channels by pressing **FAVORITE**.

To set up the favorite channel list:

- 1 Press **MENU**. The on-screen menu opens.

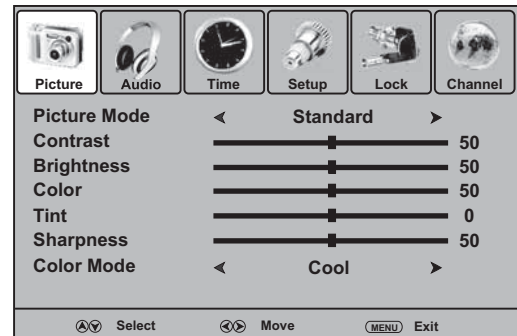

- 2 Press **◀** or **▶** to select **Channel**, then press **▼**. The *Channel* menu opens.

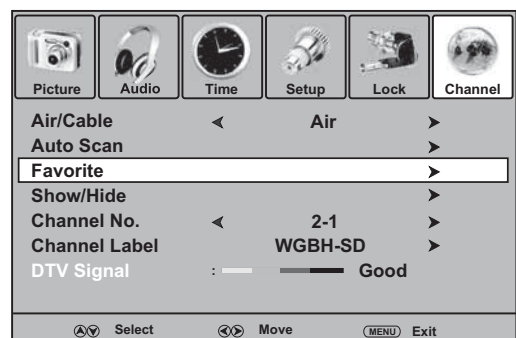

- Press **▲** or **▼** to highlight **Favorite**, then press **▶** or **ENTER**. The favorite channel list opens.

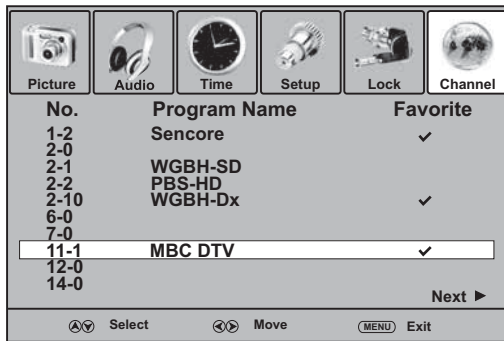

- Press **▲** or **▼** to highlight the channel you want to add to the favorite list, then press **ENTER** to mark the channel. A check mark appears if the channel is added to the list. The check mark disappears if you delete the channel from the list.

Note
If the list has more than one page, press **◀** or **▶** to scroll through the pages.

- Press **EXIT** to close the menu.
- To select a channel in the favorite channel list, press **FAVORITE**, press **▲** or **▼** to highlight the channel, then press **ENTER**.

Labeling channels

You can add a label to a channel to make it easier to identify.

To label a channel:

- Tune to the channel you want to label.
- Press **MENU**. The on-screen menu opens.

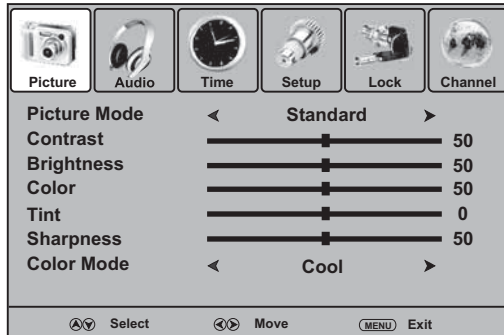

- Press **◀** or **▶** to select **Channel**, then press **▼**. The *Channel* menu opens.



- Press **▲** or **▼** to highlight **Channel Label**, then press **▶** or **ENTER**. The channel label screen opens.

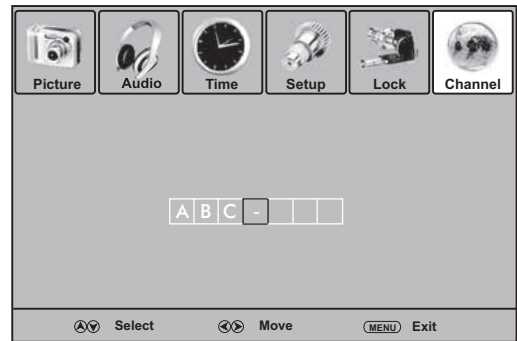

- Press **▲** or **▼** to enter a character, then press **◀** or **▶** to move to the next character. Repeat this step to add more characters.
- Press **ENTER** to add the label.
- Press **EXIT** to close the menu.

Note
If a channel label is provided with the TV signal, your TV displays the channel label you added.

Selecting the on-screen menu language

To select the on-screen menu language:

- Press **MENU**. The on-screen menu opens.

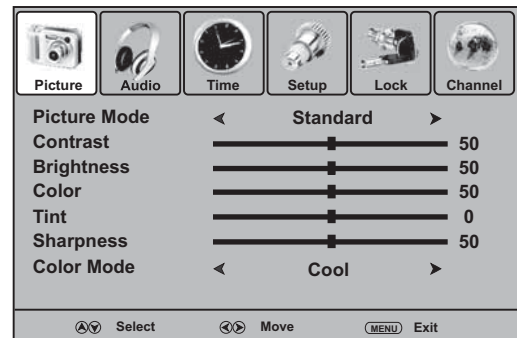

- Press **◀** or **▶** to select **Setup**, then press **▼**. The *Setup* menu opens.

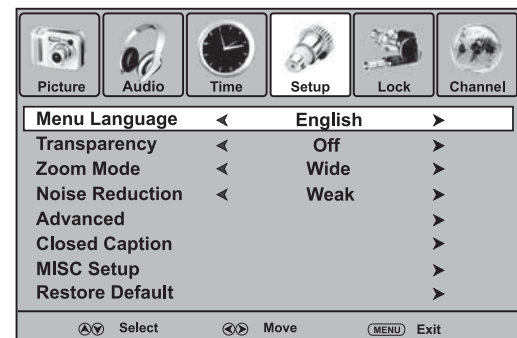

- Press **▲** or **▼** to select **Menu Language**, then press **◀** or **▶** to select the menu language you want.
- Press **EXIT** to close the menu.

Displaying the information banner

Your TV has an information banner that displays status information, such as the channel number or video input source. In DTV mode, additional information may appear, such as the channel name and signal resolution.

To display the information banner:

- Press **DISPLAY**. The information banner opens.
- To close the banner, press this button again or wait a few seconds and the banner closes automatically.

Displaying the DTV program guide

In DTV mode, your TV can display a program guide, if available. The guide may show a list of available programs, program times, and program summaries. The displayed information is provided by the DTV channel.

To display the DTV program guide:

- Press **GUIDE**. The program guide opens. If there is additional program information, press this button to display the information.
- To close the program guide, press this button or wait a few seconds and the banner closes automatically.

Checking the DTV signal strength

You can check the DTV signal strength to determine if you need to adjust your antenna or digital cable input. The higher the signal strength, the less likely you are to experience picture degradation.

To check the DTV signal strength:

- 1 Press **MENU**. The on-screen menu opens.

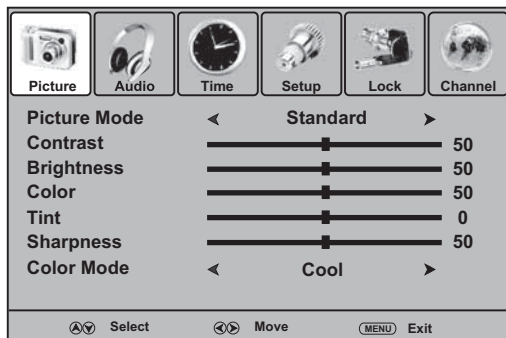

- 2 Press **◀** or **▶** to select **Channel**, then press **▼**. The **Channel** menu opens. The **DTV Signal** bar appears at the bottom of the menu.



- 3 Press **EXIT** to close the menu.

Playing TV audio only

You can turn off the video for a TV broadcast and listen to the audio only.

To play TV audio only:

- 1 Press **MENU**. The on-screen menu opens.

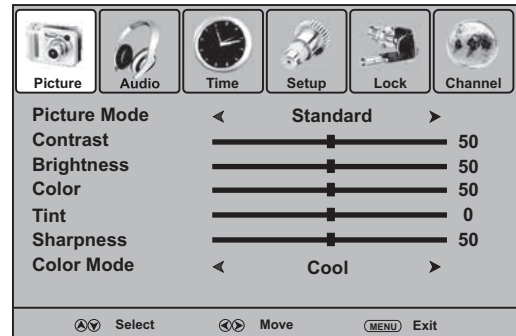

- 2 Press **◀** or **▶** to select **Setup**, then press **▼**. The **Setup** menu opens.

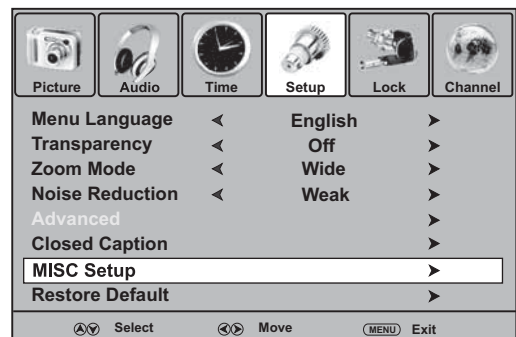

- 3 Press **▲** or **▼** to select **MISC Setup**, then press **▶** or **ENTER**.

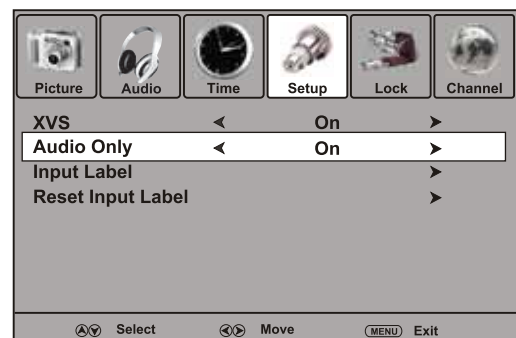

- 4 Press **▲** or **▼** to select **Audio Only**, then press **◀** or **▶** to select **On**.
- 5 Press **EXIT** to close the menu.

Notes

- **Audio Only** only works when the input source is TV and your TV is receiving a broadcast signal.
- To exit **Audio Only** mode, press any button.
- When you exit **Audio Only** mode, the **Audio Only** option is automatically reset to **Off**.

Labeling an input source

You can label a device connected to input jacks to make the device easier to select. For example, if you have a DVD player connected to the **AV 1 IN** jacks, you can label that source DVD. When you press **INPUT**, **DVD** appears instead of **AV1**.

To label an input source:

- 1 Press **MENU**. The on-screen menu opens.

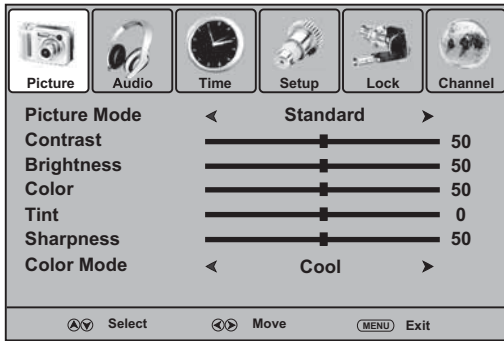

- 2 Press **◀** or **▶** to select **Setup**, then press **▼**. The *Setup* menu opens.

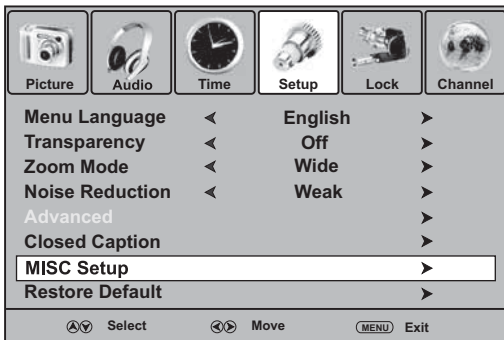

- 3 Press **▲** or **▼** to select **MISC Setup**, then press **▶** or **ENTER**.

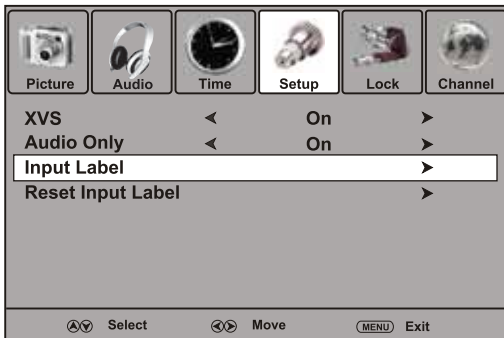

- 4 Press **▲** or **▼** to select **Input Label**, then press **▶** or **ENTER**.

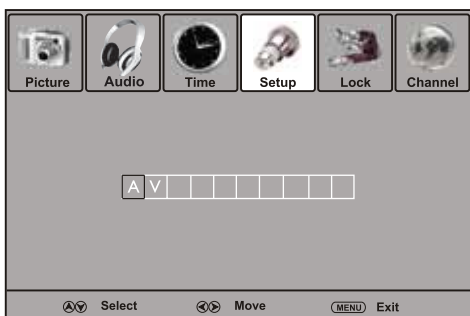

- 5 Press **▲** or **▼** to select a character, the press **◀** or **▶** to move to a different character position.
- 6 Press **ENTER** or **MENU** to save the label and return to *MISC Setup* menu, or wait several seconds for the menu to save the label and close automatically.

Resetting an input label

To reset an input label to the factory default:

- 1 Press **MENU**. The on-screen menu opens.

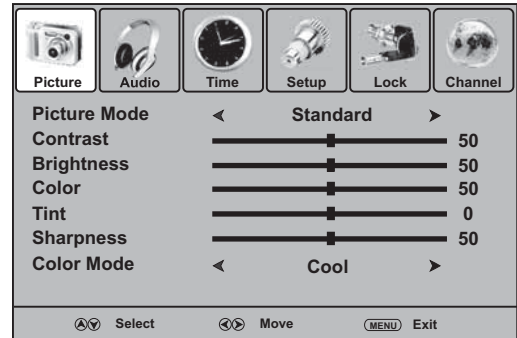

- 2 Press **◀** or **▶** to select **Setup**, then press **▼**. The *Setup* menu opens.

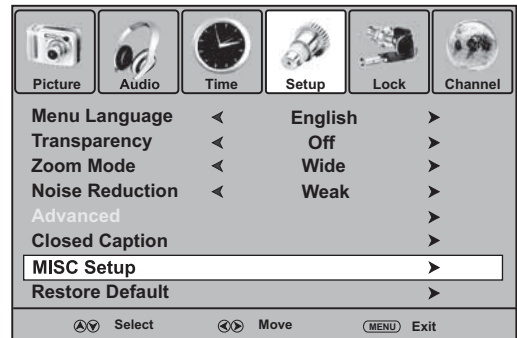

- 3 Press **▲** or **▼** to select **MISC Setup**, then press **▶** or **ENTER**.

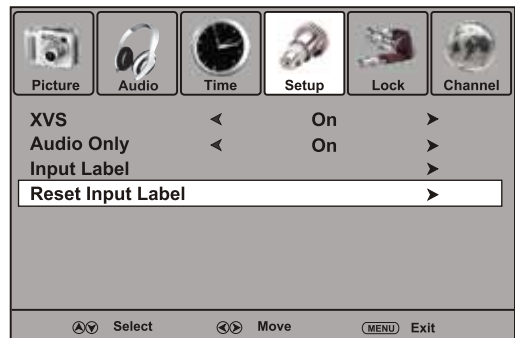

- 4 Press **▲** or **▼** to select **Reset Input Label**, then press **ENTER**. A confirmation box opens.
- 5 Select **Yes** and press **ENTER** to reset the label, or select **No** and press **ENTER** to cancel.
- 6 Press **EXIT** to close the menu.

Setting the parental password

Your TV lets you control which programs and movies your children can watch based on industry ratings. To set up parental control, you have to enter a password.

To set the parental password:

- 1 Press **MENU**. The on-screen menu opens.

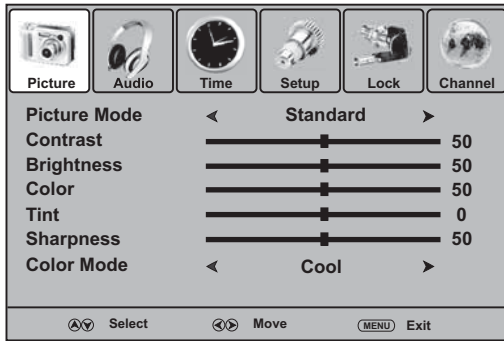

- 2 Press **◀** or **▶** to select **Lock**, then press **▼**. The *Enter Password* screen opens.

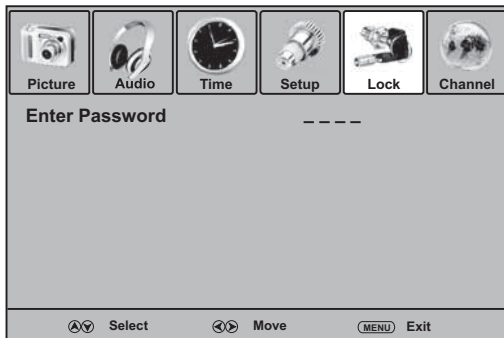

- 3 Press the number buttons to enter the four-digit password. The default password is **0000**. You should change the password to a number you can remember. The *Lock* menu opens.

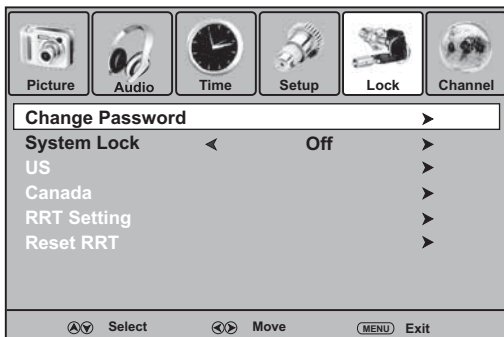

- 4 Press **▲** or **▼** to select **Change Password**, then press **▶** or **ENTER**. The password entry screen opens.

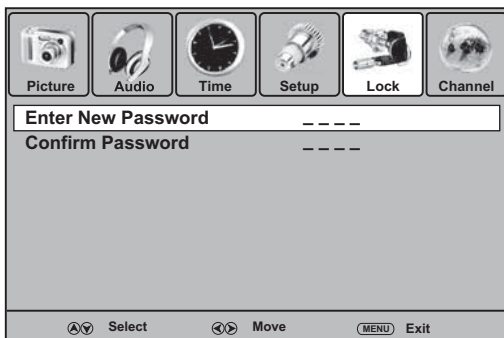

- 5 Press the number buttons to enter the new password, then enter the new password again. The *Lock* menu reopens.

Note
If you forget your password, enter **1397**.

- 6 Press **EXIT** to close the menu.

Turning the parental lock on or off

To turn the parental lock on or off:

- 1 Press **MENU**. The on-screen menu opens.

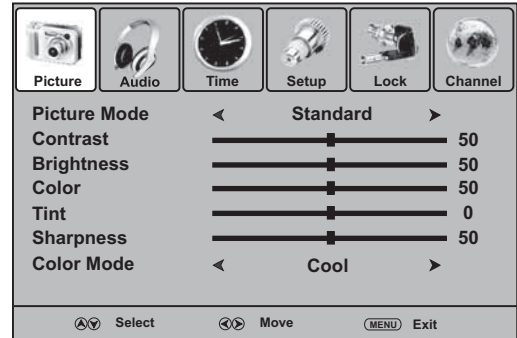

- 2 Press **◀** or **▶** to select **Lock**, then press **▼**. The *Enter Password* screen opens.

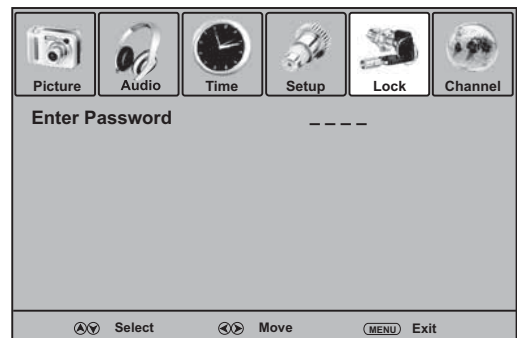

- 3 Press the number buttons to enter the four-digit password. The default password is **0000**. The *Lock* menu opens.

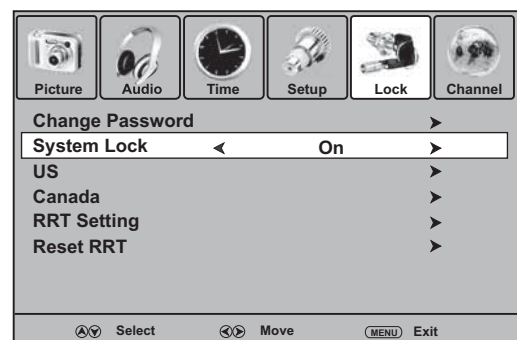

- 4 Press **▲** or **▼** to select **System Lock**, then press **◀** or **▶** to select **On** or **Off**.
- 5 Press **EXIT** to close the menu.

Setting parental controls

You can set parental controls for the U.S. and Canada. The following task shows how to set controls for U.S. TV ratings. You use similar steps for controlling U.S. movie and Canadian TV ratings.

To set parental controls:

1 Press **MENU**. The on-screen menu opens.

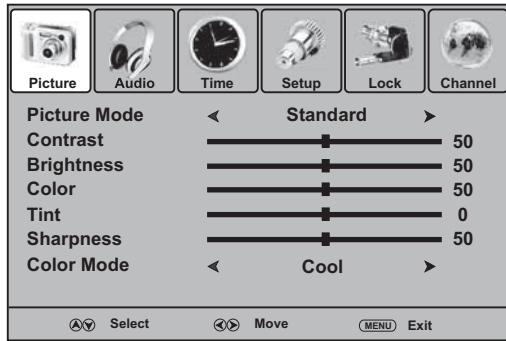

2 Press **◀** or **▶** to select **Lock**, then press **▼**. The *Enter Password* screen opens.

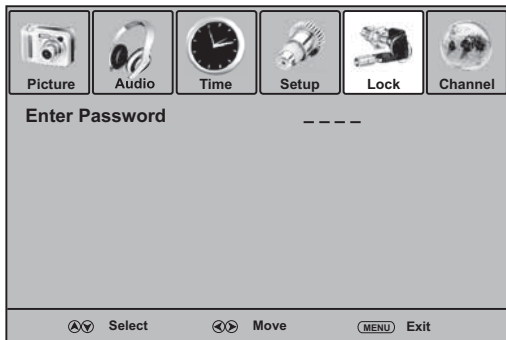

3 Press the number buttons to enter the four-digit password. The default password is **0000**. The *Lock* menu opens.

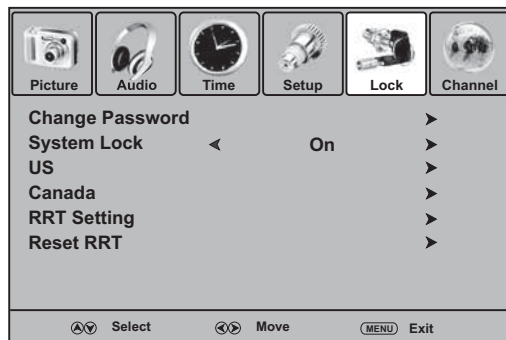

4 Press **▲** or **▼** to select **US**, then press **▶** or **ENTER**. The U.S. ratings menu opens.

Note
Select **Canada** to set Canadian TV controls.

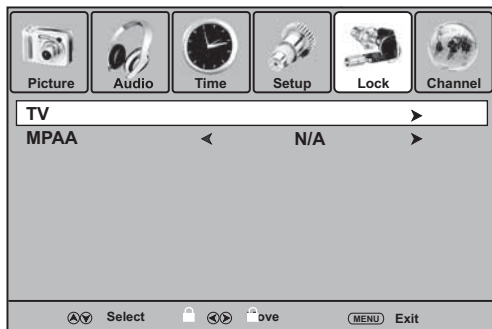

5 Press **▲** or **▼** to highlight **TV**, then press **▶** or **ENTER**. The U.S. *TV RATING* screen opens.

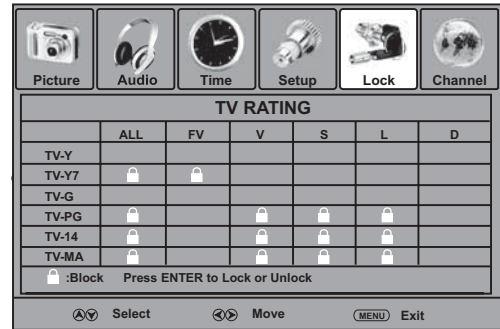

6 Press **▲** **▼** **◀** or **▶** to select the rating you want to block, then press **ENTER**. A lock symbol appears when a rating is blocked.

7 Press **EXIT** to close the menu.

U.S. TV ratings (age-based)

Y	All children.
Y7	Suitable for children 7 and older.
G	General audiences.
PG	Parental guidance suggested.
14	Parental guidance strongly suggested.
MA	Mature audiences only.

U. S. TV ratings (content-based)

FV	Fantasy violence.
V	Violence.
S	Sexual situations.
L	Strong language.
D	Suggestive dialog.

U.S. movie ratings

G	General audiences.
PG	Parental guidance suggested.
PG-13	Suitable for children 13 and older.
R	Parental guidance suggested for children under 17.
NC-17	Not suitable for children under 17.
X	Adults only.
N/A	Movie is not rated.

Canadian English ratings

E	Exempt programming.
C	Suitable for all children.
C8+	Suitable for children 8 and older.
G	General audiences.
PG	Parental guidance suggested.
14+	Suitable for children 14 and older.
18+	Adults only.

Canadian French ratings

E	Exempt programming.
G	General audiences.
8 ans+	Suitable for children 8 and older.
13 ans+	Suitable for children 13 and older.
16 ans+	Suitable for children 16 and older.
18 ans+	Adults only.

Downloading rating information

You can download rating information to use when setting parental controls.

To download rating information:

- 1 Press **MENU**. The on-screen menu opens.

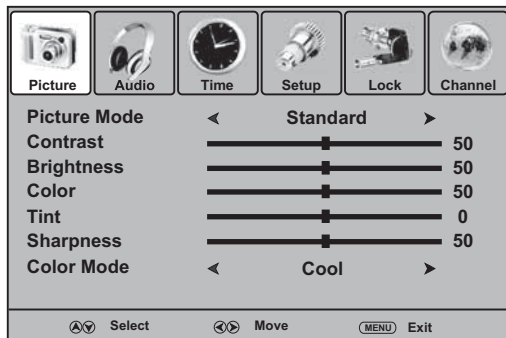

- 2 Press **◀** or **▶** to select **Lock**, then press **▼**. The *Enter Password* screen opens.

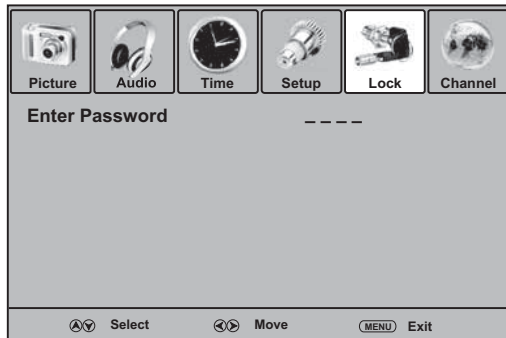

- 3 Press the number buttons to enter the four-digit password. The default password is **0000**. The *Lock* menu opens.



- 4 Press **▲** or **▼** to highlight **RRT Setting**, then press **▶** or **ENTER**. If the program is broadcast with RRT5 rating information, the rating information is downloaded automatically.

Note

If you want to clear the downloaded rating information, select **Reset RRT**. The rating information is cleared. If rating information is broadcast by another program, your TV downloads the new rating information.

Adjusting the computer image

To adjust the computer image:

- 1 Make sure that your TV is in VGA mode. For more information, see "Selecting the video input source" on page 11.

- 2 Press **MENU**. The on-screen menu opens.

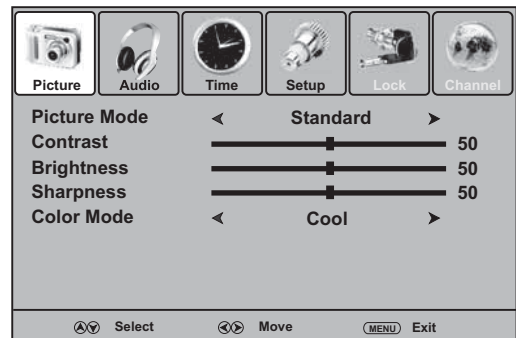

- 3 Press **▲** or **▼** to select an option, then press **◀** or **▶** to adjust the option. You can adjust:

- **Picture mode**—Selects the picture mode. You can select **Standard** (standard picture), **Dynamic** (bright, vivid picture), **Soft** (finely detailed picture), or **Personal** (customized picture). You can also press **PICTURE** to select the picture mode.
- **Contrast**—Adjusts the contrast.
- **Brightness**—Adjusts the brightness.
- **Sharpness**—Adjusts the sharpness.
- **Color Mode**—Selects the color temperature. You can select **Warm** (enhances "hotter" colors such as red), **Cool** (softens the colors and adds more blue), or **Normal** (does not adjust the colors).

- 4 Press **MENU** to return to the previous menu, or press **EXIT** to close the menu.

Adjusting advanced computer settings

To adjust advanced computer settings:

- 1 Make sure that your TV is in VGA mode. For more information, see "Selecting the video input source" on page 11.
- 2 Press **MENU**. The on-screen menu opens.

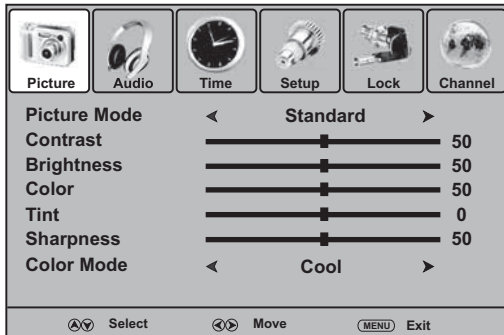

- 3 Press **◀** or **▶** to select **Setup**, then press **▼**. The *Setup* menu opens.

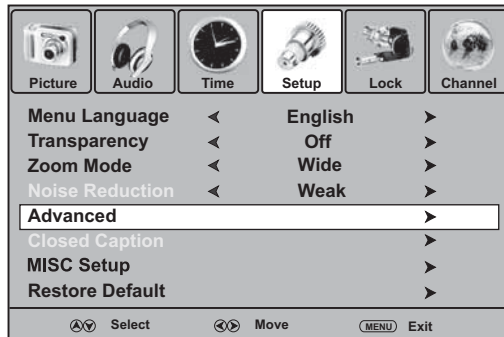

- 4 Press **▲** or **▼** to select **Advanced**, then press **▶** or **ENTER**. The advanced menu opens.
- 5 Press **▲** or **▼** to select an option, then press **◀** or **▶** to adjust the option. You can adjust:
 - **H-Pos**—Moves the image right or left.
 - **V-Pos**—Moves the image up or down.
 - **Clock**—Adjusts the sample frequency.
 - **Phase**—Adjusts the focus of stable images.
 - **Auto**—Automatically adjusts the advanced options.
- 6 Press **MENU** to return to the previous menu, or press **EXIT** to close the menu.

Adjusting the menu transparency

To adjust the menu transparency:

- 1 Press **MENU**. The on-screen menu opens.

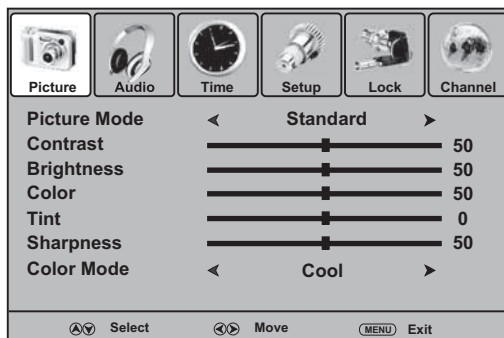

- 2 Press **◀** or **▶** to select **Setup**, then press **▼**. The *Setup* menu opens.

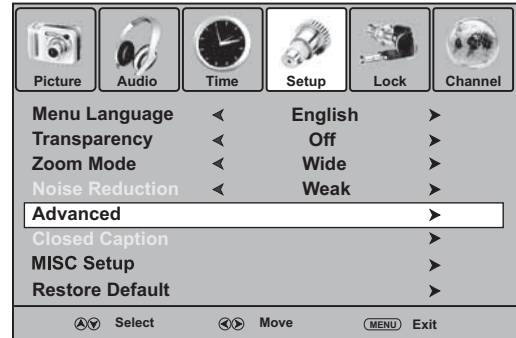

- 3 Press **▲** or **▼** to select **Transparency**, then press **◀** or **▶** to select **On** or **Off**.
- 4 Press **MENU** to return to the previous menu, or press **EXIT** to close the menu.

Restoring default settings

Caution

When you restore default settings, all the settings you have customized are reset, except for the parental password and parental ratings. You will need to scan for channels after you restore defaults.

To restore default settings:

- 1 Press **MENU**. The on-screen menu opens.

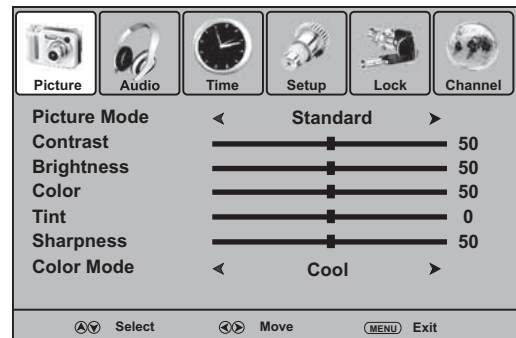

- 2 Press **◀** or **▶** to select **Setup**, then press **▼**. The *Setup* menu opens.

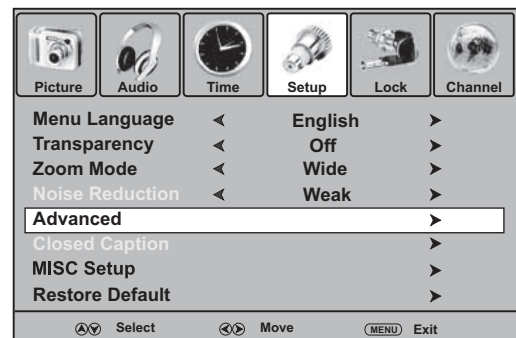

- 3 Press **▲** or **▼** to select **Restore Default**, then press **▶** or **ENTER**.
- 4 Press **MENU** to return to the previous menu, or press **EXIT** to close the menu.

Maintaining

Cleaning

- Clean your TV with a soft, dry cloth. If surfaces are extremely dirty, use a soft cloth dampened with a weak detergent solution.
- Use an eyeglass cleaner to clean the screen.
- Never use alcohol, paint thinner, or benzine.
- Before using a chemically treated cloth, read the instructions that came with the cloth.

Troubleshooting

Warning

Do not try to repair your TV yourself. Contact authorized service personnel.

Remote control

Problem	Solution
Remote control does not work.	<ul style="list-style-type: none"> • Replace the batteries. For more information, see "Installing remote control batteries" on page 7. • Make sure that the batteries are inserted correctly. For more information, see "Installing remote control batteries" on page 7. • Make sure that the power cord is plugged into a power outlet.

Video and audio

Problem	Solution
No picture or sound (the screen is not lit).	<ul style="list-style-type: none"> • Make sure that the power cord is plugged into a power outlet. • Press ⏻ (power) on your TV or the remote control. • Try another channel. The problem could be with the TV station.
Dark, poor, or no picture (the screen is lit), but sound is good.	<ul style="list-style-type: none"> • Select the correct picture mode. For more information, see "Adjusting the picture" on page 14. • Adjust the brightness. For more information, see "Adjusting the picture" on page 14. • Make sure that the antenna or cable TV is connected correctly. For more information, see "Connecting an antenna, cable TV, or satellite TV box" on page 7.
No color, picture is dark, or color is not correct.	<ul style="list-style-type: none"> • Adjust the color saturation. For more information, see "Adjusting the picture" on page 14.
Only noise (snow) appears on the screen.	<ul style="list-style-type: none"> • Make sure that the antenna or cable TV is connected correctly. For more information, see "Connecting an antenna, cable TV, or satellite TV box" on page 7. • Try another channel. The problem could be with the TV station.

Problem	Solution
Picture has dotted lines or stripes.	<ul style="list-style-type: none"> • Adjust the antenna. • Move your TV away from noise sources, such as cars, neon signs, or hair dryers.
Picture has double images.	<ul style="list-style-type: none"> • Use a highly directional outdoor antenna or switch to cable or satellite TV.
Good picture, no sound.	<ul style="list-style-type: none"> • Increase the volume. • Press MUTE to make sure that the sound is not muted. • Make sure that the audio mode is set to STEREO or MONO. For more information, see "Selecting the audio mode" on page 15.
Audio noise or static.	<ul style="list-style-type: none"> • Move radio frequency communication equipment, such as a cordless phone, away from your TV.

General

Problem	Solution
Cannot tune to one or more channels.	<ul style="list-style-type: none"> • The program you want to watch may be blocked through the parental controls. For more information, see "Setting parental controls" on page 22 or "Turning the parental lock on or off" on page 22. • The channel may have been deleted from the channel list. You can tune to the channel by pressing the number buttons or you can add the channel back to the channel list. For more information, see "Deleting channels" on page 13.
Password is lost.	<ul style="list-style-type: none"> • On the <i>Lock</i> menu, enter 1397 for the password, then set a new password. For more information, see "Setting the parental password" on page 21.
Cannot access some items.	<ul style="list-style-type: none"> • If a setting or option is grayed out, it is not available in the current input mode.
TV cabinet creaks.	<ul style="list-style-type: none"> • When you are using your TV, the temperature inside the cabinet increases. This causes the cabinet to expand or contract, which produces the creaking noise. This is not a malfunction.
Buttons do not work.	<ul style="list-style-type: none"> • Unplug the power cord for a few seconds, then plug it back in and turn on your TV.

Specifications

Design and specifications are subject to change without notice.

Dimensions and weight are approximate.

TV type	LCD
TV panel	37-inch TFT LCD
TV system	NTSC-M, ATSC
Channels	VHF: 2 - 13 UHF: 14 - 69 CATV: 1 - 125 CADTV: 1-135 DTV: 2 - 69
Audio multiplex	BTSC system
Audio output	7 W × 2
Power requirement	AC 120 V, 60 Hz
Power consumption	220 W
Dimensions	36.6 × 26.7 × 11.8 inches (92.9 × 67.8 × 30 cm)
Weight	57.3 lbs. (26 kg)
Input terminals	Composite video/left and right audio × 2 S-Video × 2 Component video/left and right audio × 2 HDMI × 3 VGA/audio Antenna
Output terminals	Composite video/left and right audio Headphone jack S/PDIF (optical)
Control terminals	RS-232

Legal notices

FCC Part 15

This device complies with Part 15 of the FCC Rules. Operation of this product is subject to the following two conditions: (1) this device may not cause harmful interference, and (2) this device must accept any interference received, including interference that may cause undesired operation.

FCC warning

Changes or modifications not expressly approved by the party responsible for compliance with the FCC Rules could void the user's authority to operate this equipment.

One year limited warranty

Insignia Products ("Insignia") warrants to you, the original purchaser of this new **NS-LCD37HD-09** ("Product"), that the Product shall be free of defects in the original manufacture of the material or workmanship for a period of one (1) year from the date of your purchase of the Product ("Warranty Period"). This Product must be purchased from an authorized dealer of Insignia brand products and packaged with this warranty statement. This warranty does not cover refurbished Product. If you notify Insignia during the Warranty Period of a defect covered by this warranty that requires service, terms of this warranty apply.

How long does the coverage last?

The Warranty Period lasts for 1 year (365 days) from the date you purchased the Product. The purchase date is printed on the receipt you received with the Product.

What does this warranty cover?

During the Warranty Period, if the original manufacture of the material or workmanship of the Product is determined to be defective by an authorized Insignia repair center or store personnel, Insignia will (at its sole option): (1) repair the Product with new or rebuilt parts; or (2) replace the Product at no charge with new or rebuilt comparable products or parts. Products and parts replaced under this warranty become the property of Insignia and are not returned to you. If service of Products or parts are required after the Warranty Period expires, you must pay all labor and parts charges. This warranty lasts as long as you own your Insignia Product during the Warranty Period. Warranty coverage terminates if you sell or otherwise transfer the Product.

How to obtain warranty service?

If you purchased the Product at a retail store location, take your original receipt and the Product to the store you purchased it from. Make sure that you place the Product in its original packaging or packaging that provides the same amount of protection as the original packaging. If you purchased the Product from an online web site, mail your original receipt and the Product to the address listed on the web site. Make sure that you put the Product in its original packaging or packaging that provides the same amount of protection as the original packaging.

To obtain in-home warranty service for a television with a screen 25 inches or larger, call 1-888-BESTBUY. Call agents will diagnose and correct the issue over the phone or will have an Insignia-approved repair person dispatched to your home.

Where is the warranty valid?

This warranty is valid only to the original purchaser of the product in the United States and Canada.

What does the warranty not cover?

This warranty does not cover:

- Customer instruction
- Installation
- Set up adjustments
- Cosmetic damage
- Damage due to acts of God, such as lightning strikes
- Accident
- Misuse
- Abuse
- Negligence
- Commercial use
- Modification of any part of the Product, including the antenna
- Plasma display panel damaged by static (non-moving) images applied for lengthy periods (burn-in).

This warranty also does not cover:

- Damage due to incorrect operation or maintenance
- Connection to an incorrect voltage supply
- Attempted repair by anyone other than a facility authorized by Insignia to service the Product
- Products sold as is or with all faults
- Consumables, such as fuses or batteries
- Products where the factory applied serial number has been altered or removed

REPAIR REPLACEMENT AS PROVIDED UNDER THIS WARRANTY IS YOUR EXCLUSIVE REMEDY. INSIGNIA SHALL NOT BE LIABLE FOR ANY INCIDENTAL OR CONSEQUENTIAL DAMAGES FOR THE BREACH OF ANY EXPRESS OR IMPLIED WARRANTY ON THIS PRODUCT, INCLUDING, BUT NOT LIMITED TO, LOST DATA, LOSS OF USE OF YOUR PRODUCT, LOST BUSINESS OR LOST PROFITS. INSIGNIA PRODUCTS MAKES NO OTHER EXPRESS WARRANTIES WITH RESPECT TO THE PRODUCT, ALL EXPRESS AND IMPLIED WARRANTIES FOR THE PRODUCT, INCLUDING, BUT NOT LIMITED TO, ANY IMPLIED WARRANTIES OF AND CONDITIONS OF MERCHANTABILITY AND FITNESS FOR A PARTICULAR PURPOSE, ARE LIMITED IN DURATION TO THE WARRANTY PERIOD SET FORTH ABOVE AND NO WARRANTIES, WHETHER EXPRESS OR IMPLIED, WILL APPLY AFTER THE WARRANTY PERIOD. SOME STATES, PROVINCES AND JURISDICTIONS DO NOT ALLOW LIMITATIONS ON HOW LONG AN IMPLIED WARRANTY LASTS, SO THE ABOVE LIMITATION MAY NOT APPLY TO YOU. THIS WARRANTY GIVES YOU SPECIFIC LEGAL RIGHTS, AND YOU MAY ALSO HAVE OTHER RIGHTS, WHICH VARY FROM STATE TO STATE OR PROVINCE TO PROVINCE.

Contact Insignia:

For customer service please call 1-877-467-4289
www.insignia-products.com

Distributed by Best Buy Purchasing, LLC
7601 Penn Avenue South, Richfield, Minnesota, U.S.A.
55423-3645

© 2008 Best Buy Enterprise Services, Inc.

All rights reserved. INSIGNIA is a trademark of Best Buy Enterprise Services, Inc. Registered in some countries. All other products and brand names are trademarks of their respective owners.

INSIGNIA™

www.insignia-products.com (877) 467-4289

Distributed by Best Buy Purchasing, LLC
7601 Penn Avenue South, Richfield, MN USA 55423-3645
© 2008 Best Buy Enterprise Services, Inc.

All rights reserved. INSIGNIA is a trademark of Best Buy Enterprise Services, Inc. Registered in some countries.
All other products and brand names are trademarks of their respective owners..

ENGLISH
08-1065